

# 3010 PRECISION MULTI PRODUCT CALIBRATOR

**VOLTAGE**



1000V Max.  
2 Wire Ohms



**CURRENT**



2A Max.  
4 Wire Ohms



**HIGH CURRENT**



**AUXILIARY TERMINALS**



50V Max.

NEG EARTH SCOPE FREQ/TRG

VE TO GND  
**10.000000V** DC  
0.0PPM  
+/- POWER SCOPE NEXT

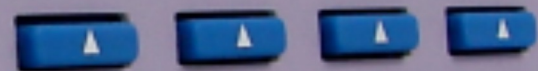

OUTPUT CONTROL

STANDBY

OUTPUT ON



RANGE ▲  
X10

RANGE ▼  
÷10

# 3000 SERIES

## OPERATION MANUAL

# TRANSMILLE

SOLUTIONS IN CALIBRATION

# **3000 Series**

## **Precision Multi Product Calibrator**

### **Operation Manual**

# **IMPORTANT NOTICE**

**THIS CALIBRATOR  
WILL  
REQUIRE AN  
UNLOCK CODE  
AFTER THE EVALUATION  
PERIOD HAS EXPIRED.**

**(60 Days after invoice date)**

**AFTER THE EVALUATION PERIOD HAS EXPIRED THE OPERATION  
OF THE CALIBRATOR IS LOCKED AND THE DISPLAY SHOWS A  
NUMBER WHICH MUST BE QUOTED TO TRANSMILLE TO RECEIVE  
THE UNLOCK CODE**

**THE UNLOCK CODE IS AVAILALBLE  
FROM TRANSMILLE  
ONLYAFTER PAYMENT  
HAS BEEN RECEIVED.**

**This code is only needs to be entered once  
in the life of the instrument.**

**Please contact Transmille or use the form in the  
back of the manual to obtain the code.**

**Transmille Ltd.  
Staplehurst , Kent.  
Tel: 44 (0)1580 890700 : Fax 44(0)1580 890711  
email:- sales@transmille.com**

**DECLARATION OF CONFORMITY**

**Manufacturer's Name:** Transmille Ltd.  
**Manufacturer's Address:** Unit 4, Select Business Centre  
 Lodge Road  
 Staplehurst  
 TN12 0QW

**Declares, that the product**

**Product Name:** Multi-product Calibrator  
**Model Number:** 3050 / 3041 / 3010  
**Product Options:** This declaration covers all options of the above product(s)

**Conforms with the following European Directives:**

**The product herewith complies with the requirements of the Low Voltage Directive 73/73EEC and the EMC Directive 89/336/EEC (including 93/68/EEC) and carries the CE Marking accordingly**

**Conforms with the following product standards:**

**EMC**

**EN 61326-1:1997+A1:1998 • EN55011:1991 (Group 1 : Class A)**

**Standard**

IEC 61000-4-2:1995+A1:1998 / EN 61000-4-2:1995  
 IEC 61000-4-3:1995 / EN 61000-4-3:1995  
 IEC 61000-4-4:1995 / EN 61000-4-4:1995  
 IEC 61000-4-5:1995 / EN 61000-4-5:1995  
 IEC 61000-4-6:1996 / EN 61000-4-6:1996  
 IEC 61000-4-11:1994 / EN 61000-4-11:1994

**Limit**

4kV CD, 8kV AD  
 3 V/m, 80-1000 MHz  
 0.5kV signal lines, 1kV power lines  
 0.5kV line-line, 1kV line-ground  
 3V, 0.15-80 MHz / cycle, 100%  
 Dips: 30% 10ms; 60% 100ms  
 Interrupt > 95% @ 5000ms

**SAFETY**

IEC 61010-1:1990+A1:1992+A2:1995 / EN 61010-1:1993+A2:1995

16/01/2006

**Revision No: 1.0**  
**Date :16/01/2006**

**Managing Director**

# TABLE OF CONTENTS

<b>3000 SERIES CALIBRATOR INTRODUCTION.....</b>	<b>6</b>
MAIN FEATURES .....	6
ACCURACY AND FUNCTIONALITY .....	7
TRUE MULTIPRODUCT CALIBRATION FROM ONE INSTRUMENT .....	7
RETRO FITTABLE OPTIONS ALLOWS EXTRA FUNCTIONS TO BE ADDED AS REQUIRED. ....	7
SERIAL LINE RS232 INTERFACE AVAILABLE AS STANDARD.....	8
OUTPUT CONNECTION .....	8
<b>PREPARING THE CALIBRATOR FOR USE.....</b>	<b>9</b>
INITIAL INSPECTION.....	9
LIFTING AND CARRYING THE CALIBRATOR .....	9
POSITIONING THE CALIBRATOR.....	10
REAR PANEL CONNECTIONS AND CONTROLS .....	11
SETTING AND CHECKING THE LINE VOLTAGE. ....	12
POWER LINE INLET FUSE AND RATING.....	12
CONNECTING TO A COMPUTER.....	13
POWERING UP THE CALIBRATOR .....	13
OUTPUT CONNECTIONS .....	14
OUTPUT OVERLOADS.....	15
<b>OPERATION .....</b>	<b>16</b>
SAFETY WARNINGS .....	16
INTRODUCTION TO OPERATION .....	16
FRONT PANEL CONTROLS AND INDICATORS .....	17
FRONT PANEL KEYBOARD .....	17
FRONT PANEL KEYBOARD – CONTROL SECTIONS.....	18
GRAPHIC LCD DISPLAY .....	19
DIGITAL CONTROL .....	20
TERMINAL STATUS LED'S.....	21
9 PIN ADAPTER INTERFACE CONNECTOR.....	23
SETTING A VOLTAGE OR CURRENT OUTPUT .....	24
ADJUSTING THE SET OUTPUT USING THE DIGITAL CONTROL.....	24
AUTOMATIC DISPLAY OF % OR PPM ERROR AND REF. KEY .....	25
SELECTING AC AND SETTING A FREQUENCY.....	26
RETURNING THE CALIBRATOR TO DC .....	27
SETTING 2 WIRE RESISTANCE OUTPUT. ....	28
SETTING 4 WIRE RESISTANCE OUTPUT. ....	30
SETTING CAPACITANCE OUTPUT. ....	32
SETTING INDUCTANCE OUTPUT (OPTION) .....	33
THERMOCOUPLE SIMULATION (OPTION).....	34
SPECIAL FUNCTIONS AVAILABLE USING THE 'SOFT' KEYS.....	38
CONNECTING OUTPUT NEGATIVE TO LINE EARTH OR FLOATING .....	38
SELECTING FRONT PANEL CONTROL.....	39
SETTING TTL LOGIC FREQUENCY OUTPUT. ....	39
SETTING A MARK SPACE RATIO. ....	40
SELECTING PT100 RESISTANCE OUTPUT (OPTION) .....	41
SELECTING AC POWER CALIBRATION OUTPUT (OPTION).....	42
SELECTING DC POWER CALIBRATION OUTPUT (OPTION) .....	44
SELECTING OSCILLOSCOPE CALIBRATION OUTPUT (OPTION).....	45
WARNING AND OUTPUT OVERLOAD INDICATIONS. ....	47
HIGH VOLTAGE TIMEOUT.....	47
30 AMP TEMPERATURE CUT-OUT .....	47

<b>INTERFACE TYPES .....</b>	<b>48</b>
RS232 INTERFACE .....	49
USB INTERFACE.....	51
<b>REMOTE PROGRAMMING .....</b>	<b>52</b>
PROGRAMMING COMMANDS OVERVIEW .....	53
DC VOLTAGE COMMANDS.....	55
AC VOLTAGE COMMANDS .....	57
DC CURRENT COMMANDS .....	59
AC CURRENT COMMANDS .....	61
RESISTANCE COMMANDS .....	63
CAPACITANCE COMMANDS.....	65
SIMULATED RESISTANCE COMMANDS (OPTION) .....	66
SIMULATED CAPACITANCE COMMANDS (OPTION) .....	67
TTL FREQUENCY COMMANDS (OPTION) .....	69
PULSE WIDTH MODULATION COMMANDS (OPTION).....	71
INDUCTANCE COMMANDS (OPTION) .....	73
PRT COMMANDS (OPTION).....	75
THERMOCOUPLE SIMULATION COMMANDS (OPTION) .....	77
MISCELLANEOUS COMMANDS.....	80
OSCILLOSCOPE CALIBRATION COMMANDS (OPTION) .....	81
POWER CALIBRATION COMMANDS (OPTION) .....	90
<b>TECHNICAL DESCRIPTION .....</b>	<b>93</b>
GENERAL .....	93
CONSTRUCTION .....	94
INTERNAL FUSES .....	95
OPENING THE CASE .....	96
ACCESS TO INTERNAL FUSES – TOP PCB.....	97
ACCESS TO INTERNAL FUSES – FRONT PANEL PCB .....	98
POWER SUPPLY AND OUTPUT SWITCHING BOARD .....	99
PROCESSOR BOARD .....	99
MAIN ANALOGUE AMPLIFIER AND FEEDBACK BOARD.....	100
HIGH VOLTAGE AMPLIFIER AND OUTPUT .....	101
CURRENT TRANSCONDUCTANCE AMPLIFIER .....	101
OUTPUT CURRENTS SENSING & SHUNTS.....	102
<b>CALIBRATION TUTORIAL.....</b>	<b>103</b>
GETTING THE BEST OUT OF THE CALIBRATOR.....	103
<b>CALIBRATION AND MAINTENANCE .....</b>	<b>105</b>
GENERAL .....	105
ELECTRICAL SAFETY TESTS .....	105
CLEANING OF THE FAN DUCT .....	106
CLEANING THE EXTERNAL CASE .....	106
CALIBRATION.....	107
ADJUSTMENT OVERVIEW USING PC VIRTUAL FRONT PANEL SOFTWARE .....	108
ADJUSTMENT OVERVIEW USING CALIBRATOR FRONT PANEL CONTROLS .....	110
GUARANTEE AND SERVICE.....	111

## 3000 Series Calibrator Introduction



The 3000 series of calibrators offer the smallest and by far the most portable multi product multi function calibrator in the world. The 3000 series calibrator provides a fully functioned precision programmable calibration source.

### Main Features

- AC/DC Volts to 1025V
- AC/DC Current to 30 Amps (20Amps for 3050)
- AC/DC Current to 1000 Amps with 50 Turn Clamp coil Adapter
- 2 and 4 Wire Resistance to 1 GOhm (10 MOhm for 3050)
- Capacitance
- Inductance
- Logic Level Frequency
- Mark Space Ratio
- PT100 resistance Simulation
- Thermocouple Simulation
- DDS Power / Harmonics (Internal Option)
- 250/350/600MHz Oscilloscope Calibration (Internal Option)
- RS232 Serial Interface ▪ GPIB (IEEE488) Interface Option
- Extendable Range Of Adaptors via the Adapter Interface

## **Accuracy and Functionality**

---

The 3000 Series calibrators are available in 3 accuracy grades including the 3010 basic DC accuracy of 5ppm, the 3041 of 25ppm and the 3050 of 50ppm. The appearance of these units is the same however the model is indicated on the Rear panel and shown on the display at switch on. The calibrators are also available as reduced function e.g. DC volts only etc.

## **True Multiproduct Calibration From One Instrument**

---

Designed to provide an accurate cost effective portable instrument for the calibration of multimeters, clamp meters, frequency meters, temperature meters, capacitance meters. Internal retro fit options allow the calibration of power meters, oscilloscopes to 600MHz, inductance and LCR meters.

Designed for on use in the laboratory or portable on site calibration.

The 3000 series calibrator is equally suitable for use in the standards laboratory or for on site calibration work. The fast warm up time combined with the small case and low weight also make the 3000 series calibrator ideal for on site calibration. The serial interface allows direct connection to a portable PC.

## **Retro Fittable Options Allows Extra Functions To Be Added As Required.**

---

Several internal retro fit options including oscilloscope, power , inductance and PRT allow the user to select the most cost effective solution for the calibration work required at the time with the ability to add extra functions as required. External options for the calibration of clamp meters, high accuracy thermocouple simulation with auto CJC built into the TC connector, optical tachometers etc are also available controlled via the front panel adapter interface



## **Serial Line RS232 Interface**

### **Available As Standard.**

---

All functions and outputs of the series 3000 calibrator are fully programmable over the RS232 interface fitted as standard. The use of the RS232 interface saves the cost of fitting GPIB cards to the PC, and also allows easy connection to portable PC's, reducing the set up time for on site calibration.

## **Output Connection**

---

The output terminal configuration is designed to match most DMM's input connection, e.g. volts/ohms, low current and high current eliminating the need for lead changing during calibration. All outputs are isolated when not in use, an LED indicator showing the active output pair.

## Preparing The Calibrator For Use.

---

### Initial Inspection.

---

After shipment the calibrator should be inspected for any signs of external damage. Should external damage be found contact the carrier immediately. Do not connect a damaged instrument to the line power as this may result in internal damage. Please keep the original box which can be used when returning the calibrator for service and recalibration.

### Lifting and Carrying the Calibrator

---

The calibrator weighs 14.5kgs with most of the weight at the rear right hand corner. The calibrator can be carried easily by one person by supporting from underneath (note : observe all normal practices for health and safety when carrying). A custom carry case with shoulder strap is available if the calibrator is to be regularly transported - see options list. The calibrator should always be placed down on a firm flat surface on its base feet. Avoid knocking or banging the calibrator and always place down smoothly.



**Warning : DO NOT DROP THE CALIBRATOR**  
**May cause internal damage.**

---

## Positioning the Calibrator.

---

The calibrator can be used free standing on a bench or mounted in a standard 19" rack enclosure. The calibrator can be operated at any angle, the two front feet have tilt legs for bench operation. For all installations care must be taken not to cover the ventilation slots underneath or block the fan. A 2" (5cm) space behind the instrument is also required for line and interface connections.

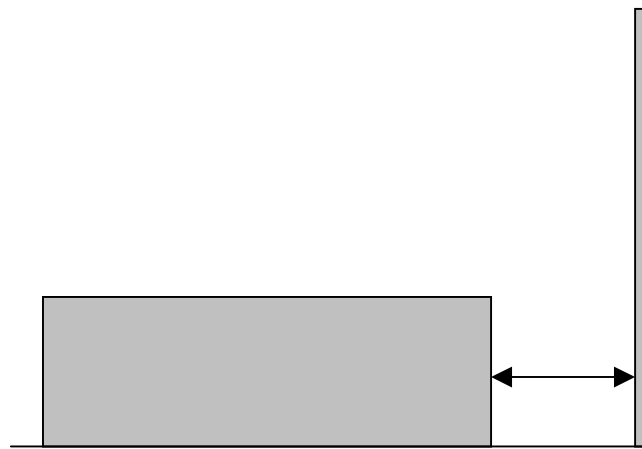

Minimum 2" (5cm) Clearance

## Rear Panel Connections and Controls

Connections on the rear panel are for Line Power via a 3 Pin IEC connector incorporating the Line fuse and on-off switch, Note the mains inlet is filtered. A 9Pin Serial interface connector for the computer interface, this is optically isolated from the calibrators output. On some models a third connector for the 10kV Extension amplifier is also present.

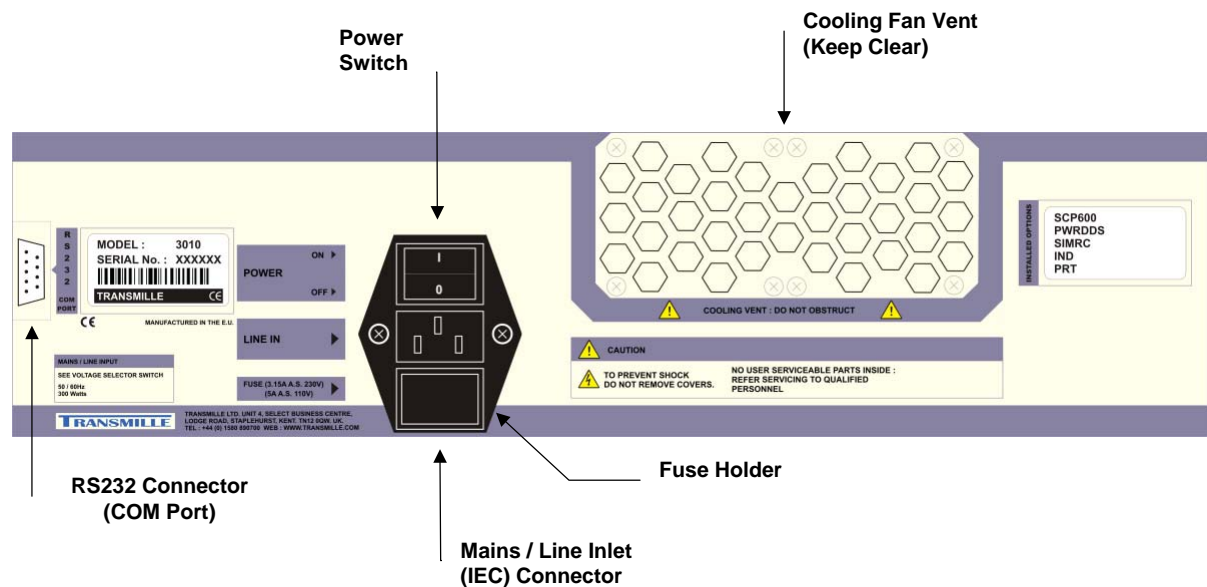

---

## Setting and checking the Line Voltage.

---



**Warning : The line power cord must have an earth conductor to avoid risk of shock.  
This instrument must be correctly earthed.**

The calibrator has been designed to work from either 100-120 Volt line supply or 200 - 240 Volt line supply. Check Supply voltage as marked on the rear panel before connecting to power line. Connecting the calibrator to the wrong supply will cause internal damage to the instrument. To change the line voltage it is necessary to remove the rear panel and rewire the transformer. The calibrator will have been shipped wired for 110V operation for USA or 230V for Europe.

---

## Power Line Inlet Fuse and rating

---

The Power line inlet fuse is located directly above the power inlet. The correct fuse rating is 3.15A Anti-surge for 230V operation and 5Amps Anti surge for 110V operation

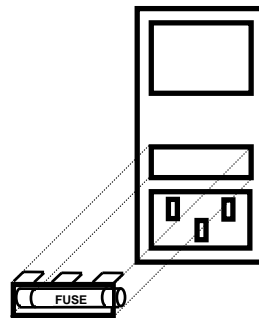

## Connecting to a computer

If required, a standard serial 9 pin cable may be used to connect the calibrator to a COM port on a PC. A Null modem cable is not needed.

RS232 Interface	
Connection	 <p style="text-align: center;"><b>3000 Series to PC RS232 Connection</b></p>
Configuration	<b>BAUD RATE : 9600</b> <b>PARITY : NONE</b> <b>DATA BITS : 8</b> <b>STOP BITS : 1</b>
Cable Type	<b>Male to Female Serial Cable</b> <b>Straight Through Pin Connection (Not Null MODEM)</b>
Driver	N/A

## Powering up the calibrator

After connecting line power, the calibrator can be switched on with the line power switch above the mains inlet socket on the rear panel.

The fan will start and the front panel display will illuminate indicating power. The display will show a firmware version number and after a short delay, during which time the processor performs a self test of the instrument, the display will show an output of **0.0000mV DC**. Allow the calibrator to warm up for 30 minutes to obtain full accuracy, the fast start feature of the calibrator will give approx. 90% of full specifications within 10 minutes. The calibrator has been designed to be powered up continuously, automatically switching to a standby mode after a pre-set period of time from the last command. In standby mode the display back light will turn off. The control program can now be started on the computer, the program will establish communication with the calibrator at which time the calibrator will download the values of the internal standards.

---

## Output Connections

---



**Warning : Risk of shock.  
High voltages may be present on the output sockets.**

Output sockets are all 4mm safety type, the voltage pairs contacts are low thermal gold plated for minimum thermal EMF.

The 3000 series calibrators outputs have been designed to allow most multimeters to be calibrated without changing ranges. There are 3 separate pairs of outputs :

- 1) Voltage, Resistance, Capacitance, frequency & Inductance
- 2) Current and 4 Wire Resistance
- 3) High 30A Current.

When an output terminal pair is not active they are completely open circuit and isolated from the other outputs. As only one pair is active at a time on (except on 4 wire ohms) they may be combined together if required to match the meters input arrangement.

One example configuration of a multimeter's inputs is a single common low input with voltage, current and high current input. To match this to the calibrator, simply connect the 3 low outputs of the calibrator together and connect the voltage, current & high current outputs to the appropriate meters input . Note that when outputting ohms, the calibrator will use the voltage output terminals.

A second example is where the meter has separate voltage and current inputs, often using four wire ohms on both pairs. In this case simply connect the voltage and current outputs to the meter's inputs, the calibrator will use both the voltage and current pair on four wire ohms.

It is recommended that the voltage and low current leads be high quality screened cable with gold plated 4mm plugs fitted. The cable must be able to withstand 1025 volts AC and have an insulation resistance greater than 1Teraohm to avoid introducing any shunting effect on the high resistance ranges.

Poor quality test leads will introduce noise, thermal emf and leakage errors on low voltage & current ranges and also unstable readings on resistance and capacitance outputs (see measurement techniques ). Special test leads are available from Transmille, see accessories.



**Warning : Under no circumstances should any voltage be connected to the calibrator outputs**

The low output can be connected to line earth or allowed to float as selected - see operation section of this manual.. It is recommended that the low is earthed which will help to reduce noise on high ohms and low current. If allowed to float with respect to line earth the low must remain within 50 volts of line earth. Outputs are optically isolated from the RS232 interface

## Output Overloads

If the calibrator is unable to drive the load then the output will be turned off and the calibrator returned to standby mode. The message **STBY !** will be displayed on the front panel. The output will be automatically reset on setting the output again.



---

## Operation

---

### Safety Warnings

---



**WARNING :** The information in this section is intended only for *qualified* personnel. The user must at all times be adequately protected from electric shock. Qualified



personnel must ensure that operators of the equipment are adequately insulated from connection points.



**WARNING :** This instrument is capable of generating both DC and AC high voltages.



A soft carry-case and a hard transit case are available for regular transportation of the calibrator.

---

## Introduction to Operation

---

All functions of the 3000 Series Calibrator can be controlled from the front panel. or controlled remotely by a computer over the interface. The front panel controls are 'locked out', but local control may be resumed by selecting a soft key - it must be remembered that this action may disrupt the computer program.

## Front Panel Controls and Indicators

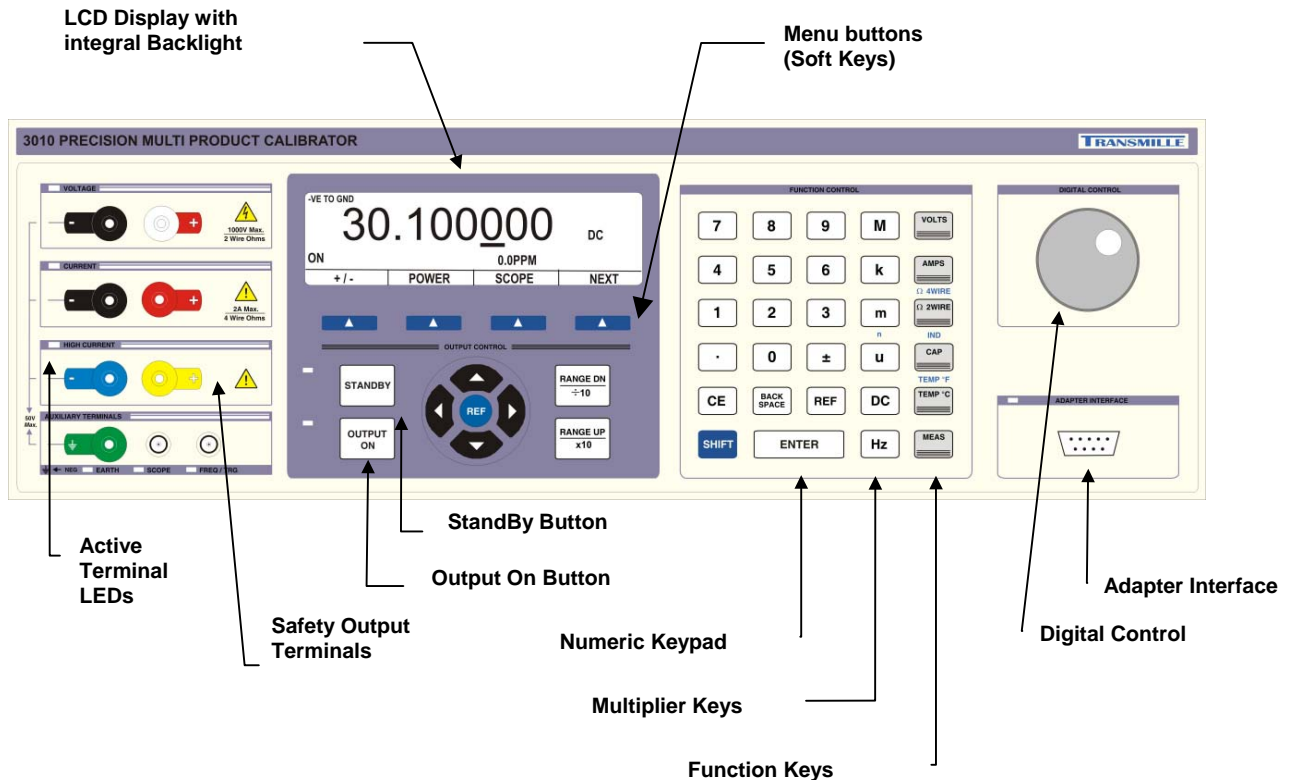

## Front Panel Keyboard





The front panel of the 3000 Series Calibrator utilises a high quality custom rubber keyboard with tactile feel buttons and integral display window. The front panel is therefore sealed against the ingress of moisture and dirt enabling the calibrator to be used in working environments without risk of dirt causing early failure of the operating buttons. The front panel can easily be wiped clean with a soft cloth. Care should be taken not scratch the display window. All graphics are 'under printed' so that they will not wear off with use.

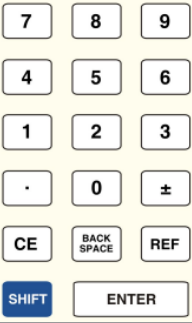

### IMPORTANT NOTE

The front panel key buttons are for use with fingers only - do not press the key with hard or sharp objects e.g. Ball-point pens, pencils, screwdrivers etc. Repeated actions like this will almost certainly cause the keyboard to fail. (This will not be covered under warranty). Care should also be taken when transporting the instrument, do not place test leads on top of the panel which may get squashed into the display area or keys which can also cause damage.

## Front Panel Keyboard – Control Sections

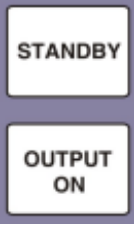
<p>The Keyboard is divided into sections to allow easy operation.</p> <p style="text-align: center;"><b>Numeric section</b></p> <p style="text-align: center;"><i>Allows numeric values to be entered</i></p>	
<p style="text-align: center;"><b>Multiplier section</b></p> <p style="text-align: center;"><i>Mega (M), Kilo (K), milli (m), micro(u) or nano (n)</i></p>	
<p style="text-align: center;"><b>Function section</b></p> <p style="text-align: center;"><i>Volts (V), Amps(A), Ohms (2 &amp; 4 Wire), Farads(F), Celsius(C), &amp; Frequency(Hz)</i></p>	
<p style="text-align: center;"><b>Range Up / Range Down</b></p> <p style="text-align: center;"><i>Allow the output to be multiplied / divided by 10.</i></p>	
<p style="text-align: center;"><b>Left / Right / Up / Down Arrow Keys</b></p> <p style="text-align: center;"><i>To select the digit to be controlled by the rotary control.</i></p>	
<p style="text-align: center;"><b>Output On / Standby keys</b></p> <p style="text-align: center;"><i>Allow the calibrators output to be disconnected from the terminals. Led indicators are incorporated in these switches to clearly show the output status.</i></p>	

## Graphic LCD Display

A back lit graphic LCD display shows the present output, instrument status, % or ppm change from the entered value, and also the new value being entered. The bottom line of the display is used to assign the function of the four 'soft (menu) keys' immediately under the display. The display utilises a back light which automatically turns off if no activity takes place. The back light turns on as soon as a key is pressed or a command is received.

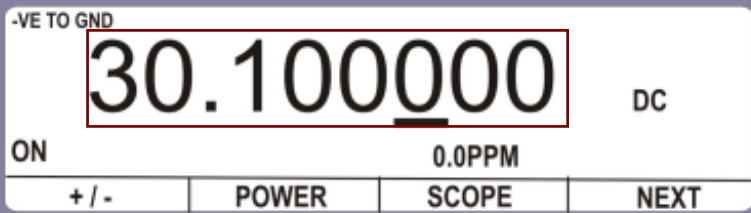
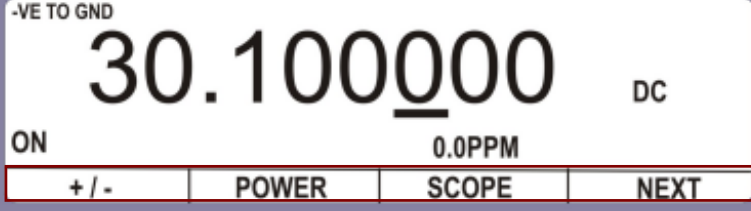
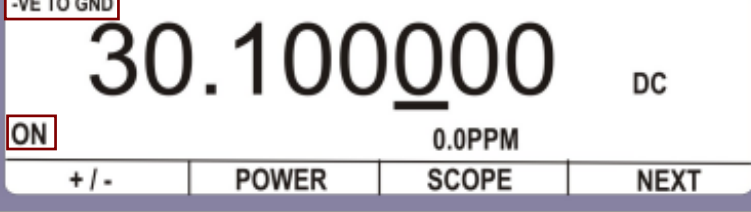
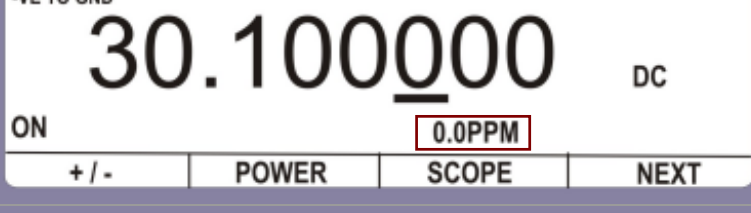
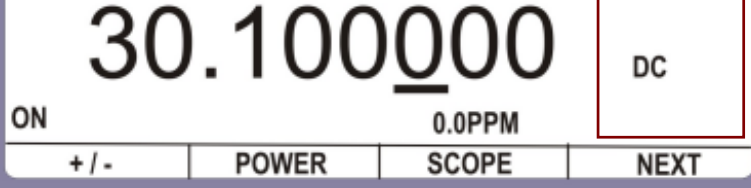
<p><b>Output Value</b></p>	 <p>The LCD display shows the output value 30.100000. A red box highlights the number. The display also shows -VE TO GND, ON, DC, 0.0PPM, and a bottom row of softkeys: +/-, POWER, SCOPE, and NEXT.</p>
<p><b>Dynamic Softkey Menu</b></p>	 <p>The LCD display shows the output value 30.100000. A red box highlights the bottom row of softkeys: +/-, POWER, SCOPE, and NEXT.</p>
<p><b>Output ON / Standby &amp; -VE TO GND Indicators</b></p>	 <p>The LCD display shows the output value 30.100000. Red boxes highlight the -VE TO GND indicator at the top left and the ON indicator at the bottom left.</p>
<p><b>Deviation (PPM)</b></p>	 <p>The LCD display shows the output value 30.100000. A red box highlights the 0.0PPM deviation value.</p>
<p><b>Function Specific Configuration Display</b></p>	 <p>The LCD display shows the output value 30.100000. A red box highlights the DC output mode indicator on the right side of the display.</p>

## Digital Control

A digital potentiometer allows 'highlighted numbers' on the display to be incremented (turning clockwise) or decremented (turning anti-clockwise). As an output is changed the deviation from the original value entered on the keyboard is shown in either % or ppm.

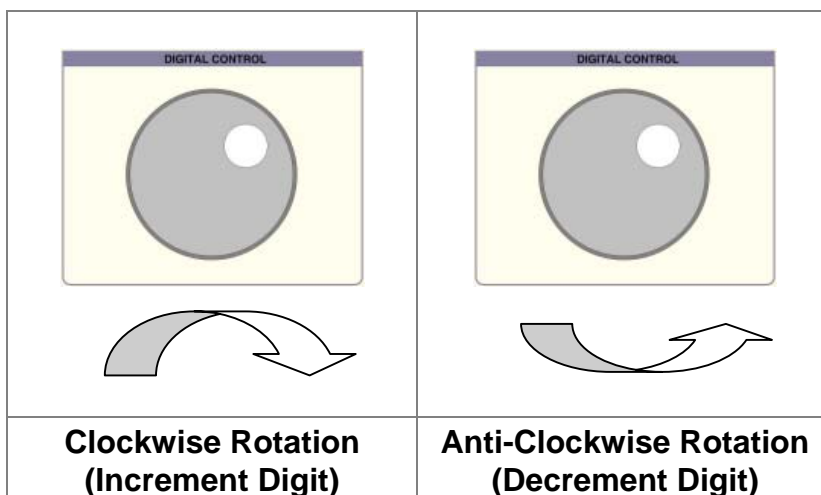
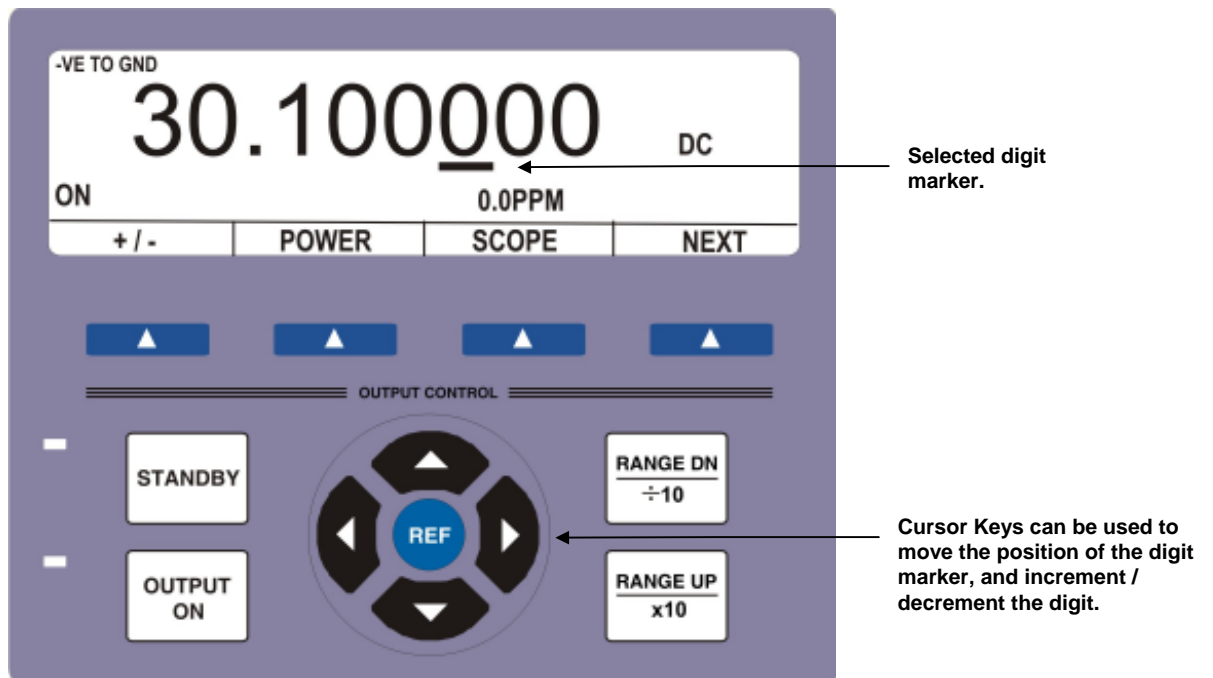

## Terminal status LED's

LED's above the terminals indicate which pair is active. When terminals are not active they are electrically isolated from each other, this enables terminals to be linked together if required.

Active terminals indicated by illuminated LED

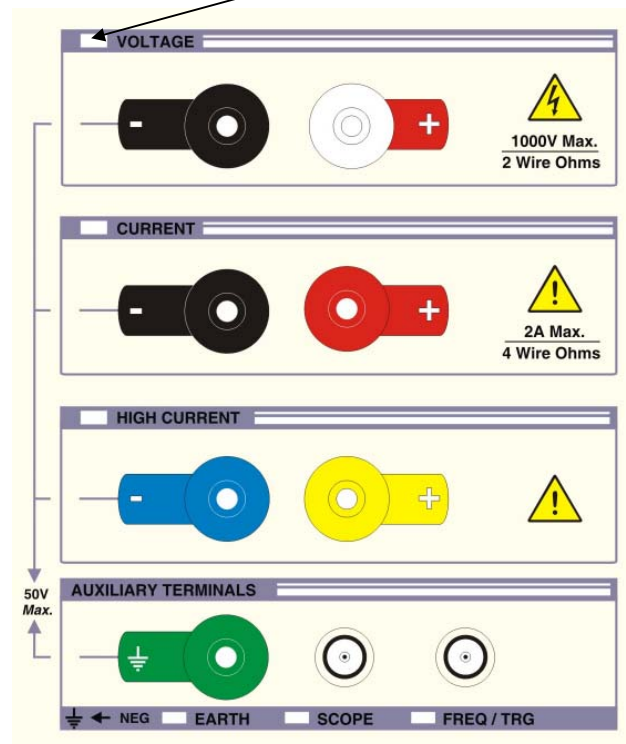

### Voltage Output Terminal Pair (Black & White)

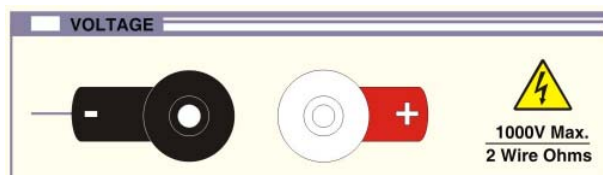

**WARNING :**  
Dangerous voltage may be present on these terminals.

### Low thermal 4mm safety terminals

Used for all voltage outputs up to 1020V, for 2 wire/4 wire resistance, and inductance (optional). *Note the low 'black' terminal can be internally switched to line earth by a soft key function. When floating, the maximum voltage on this terminal with respect to ground should not exceed 50 Volts peak.*

## Current Output Terminals (Black & Red)

4mm safety terminals for all current outputs up to 2 Amps, capacitance, TTL frequency and for sense connection for 4 wire ohms.

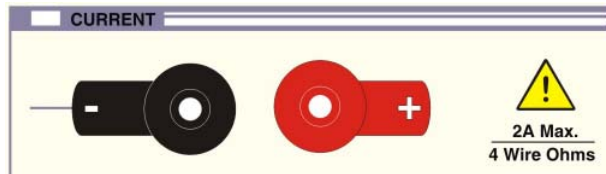

*Note the low 'black' terminal can be internally switched to line earth by a soft key function. When floating, the maximum voltage on this terminal with respect to ground should not exceed 50 Volts peak*

## 20 Amps Output Terminals (Blue and Yellow)

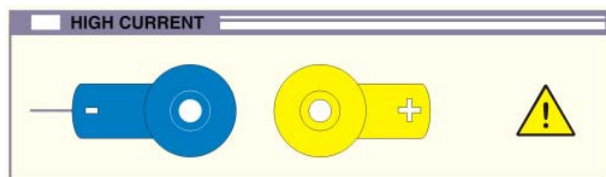

4mm Safety terminals used for all currents above 2 Amps.

## Earth Terminal (Green)

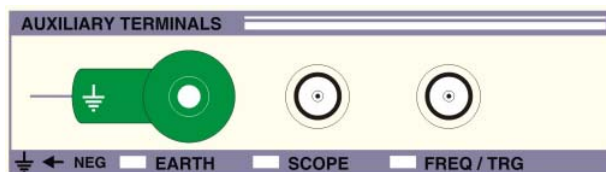

Connected directly to line earth and case. Incorporates green LED indication of Negative to earth (grounded or floating) selection

## Scope BNC Connector Output

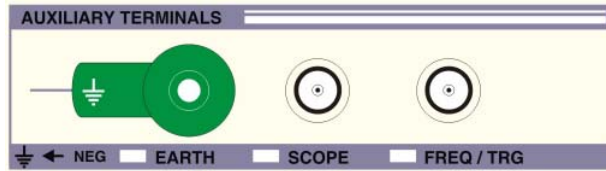

Isolated BNC Output for oscilloscope calibration. Incorporates green LED indication if BNC is the active terminal.



**WARNING :**  
Dangerous voltages up to 400V may be present on these terminals.

## 9 Pin Adapter Interface Connector.

Used for connection to external pods used for extending calibration capability, e.g. Thermocouple simulation etc.

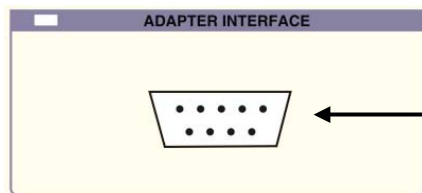

Adapter Interface 9 Way 'D' type connector (Female)

Incorporates green LED indication if adapter interface is active.



## Setting a Voltage or Current Output

To set an output follow the example below to which will set 12.345mA note that the value will appear in the display as it is entered, use 'backspace' and clear 'C' to edit an incorrect entry.

- 1) Key in the required value, e.g. '12.345'
- 2) Followed by the multiplier, e.g. 'm'
- 3) Followed by the function 'A'. Then press 'Enter'

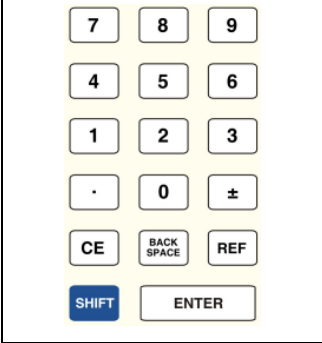
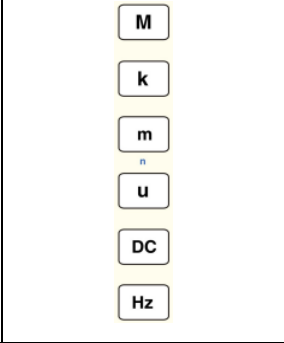
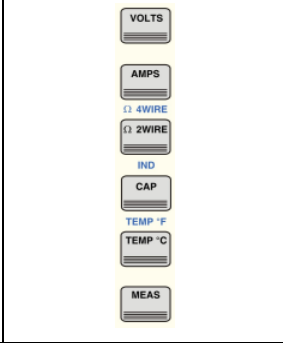
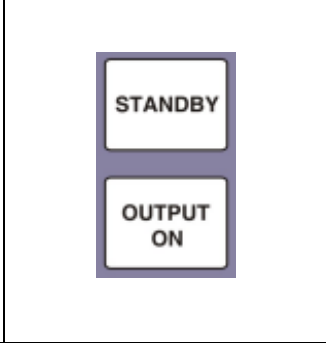
			
<p style="text-align: center;"><b>Key Digits</b> 12.345</p>	<p style="text-align: center;"><b>Press 'm'</b> <b>Multiplier</b></p>	<p style="text-align: center;"><b>Press</b> <b>Function Key</b></p>	<p style="text-align: center;"><b>Select</b> <b>Output On</b></p>

The display will now change to show the new value. The value entered will now be output by the calibrator on the appropriate terminals, except when a high voltage or current is entered. In this case, the calibrator will automatically go into standby mode. To output the voltage, press the 'Output On' key. This safety feature stops the accidental selection of high voltage or current. Once on a range, any new output within that range can be set without the calibrator returning to standby.

## Adjusting the set output using the digital control

After the output has been set, any digit of the output display can be incremented or decremented using either the digital control or the up down arrow keys. The digit selected is indicated by the cursor and can be selected using the left/right arrow keys.

## Automatic Display of % or ppm Error and Ref. Key

When the output value is changed by the methods above, the display will show the change in ppm or % from the original reference value entered from the keyboard. If needed, the reference value can be reset to the present value on the display by the REF key.

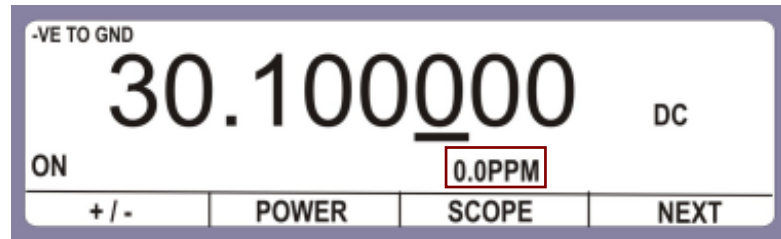

This feature is ideal for displaying the error in a meter under test by adjusting the output from the calibrator to make the meter read the nominal.

## Selecting AC and Setting a Frequency.

To set the calibrator to either AC volts or Current follow the example below which sets 1234Hz. Note that the value will appear in the display as it is entered, use 'backspace' and clear 'C' to edit an incorrect entry.

- 1) Select AC
- 2) Key in the voltage / current value
- 3) Followed by the multiplier if required
- 4) Select the function button followed by enter
- 5) Key in the required frequency, eg. '1000', followed by the function 'Hz', then Enter

<b>AC</b>					
<b>Select AC</b>	<b>Key in Voltage / Current Value</b>	<b>Select Multiplier</b>	<b>Select Function</b>	<b>Set Frequency Followed by Hz Key</b>	<b>Select Output On</b>

The display will show the frequency in the bottom right hand corner of the display. For safety, AC/DC changes will set the output to zero.

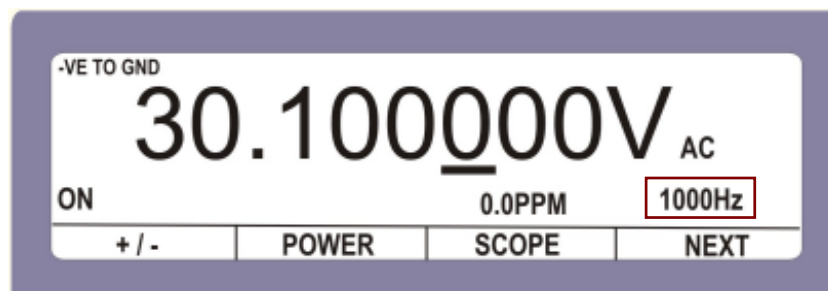

## Returning the calibrator to DC

The output can be returned to DC by following the sequence below:

- 1: Press 'DC' Key
- 2: Enter.

<div style="display: flex; flex-direction: column; align-items: center;"> <div style="border: 1px solid black; padding: 2px; margin-bottom: 2px;">M</div> <div style="border: 1px solid black; padding: 2px; margin-bottom: 2px;">k</div> <div style="border: 1px solid black; padding: 2px; margin-bottom: 2px;">m</div> <div style="border: 1px solid black; padding: 2px; margin-bottom: 2px;">u</div> <div style="border: 1px solid black; padding: 2px; margin-bottom: 2px;">DC</div> <div style="border: 1px solid black; padding: 2px; margin-bottom: 2px;">Hz</div> </div>	<div style="display: flex; flex-direction: column; align-items: center;"> <div style="display: flex; justify-content: space-around; width: 100%;"> <div style="border: 1px solid black; padding: 2px; margin: 2px;">7</div> <div style="border: 1px solid black; padding: 2px; margin: 2px;">8</div> <div style="border: 1px solid black; padding: 2px; margin: 2px;">9</div> </div> <div style="display: flex; justify-content: space-around; width: 100%;"> <div style="border: 1px solid black; padding: 2px; margin: 2px;">4</div> <div style="border: 1px solid black; padding: 2px; margin: 2px;">5</div> <div style="border: 1px solid black; padding: 2px; margin: 2px;">6</div> </div> <div style="display: flex; justify-content: space-around; width: 100%;"> <div style="border: 1px solid black; padding: 2px; margin: 2px;">1</div> <div style="border: 1px solid black; padding: 2px; margin: 2px;">2</div> <div style="border: 1px solid black; padding: 2px; margin: 2px;">3</div> </div> <div style="display: flex; justify-content: space-around; width: 100%;"> <div style="border: 1px solid black; padding: 2px; margin: 2px;">.</div> <div style="border: 1px solid black; padding: 2px; margin: 2px;">0</div> <div style="border: 1px solid black; padding: 2px; margin: 2px;">±</div> </div> <div style="display: flex; justify-content: space-around; width: 100%;"> <div style="border: 1px solid black; padding: 2px; margin: 2px;">C</div> <div style="border: 1px solid black; padding: 2px; margin: 2px;">BACK SPACE</div> <div style="border: 1px solid black; padding: 2px; margin: 2px;">AC</div> </div> <div style="display: flex; justify-content: space-around; width: 100%;"> <div style="background-color: #0056b3; color: white; padding: 2px; margin: 2px;">SHIFT</div> <div style="border: 1px solid black; padding: 2px; margin: 2px;">ENTER</div> </div> </div>
<p><b>Select DC Key</b></p>	<p><b>Press Enter</b></p>

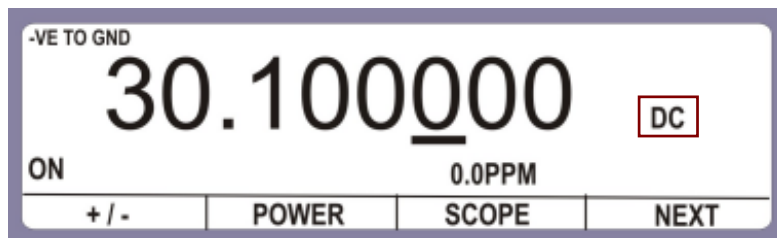

The display will show DC in the bottom right hand corner of the display. For safety, AC/DC changes will set the output to zero.

## Setting 2 Wire Resistance Output.

*Note* : The calibrator uses standard resistors of fixed decade values. The nearest available resistance to the entered value will be automatically selected. The example below selects 100kOhm in 2 wire mode.

- 1) Key in the required value, e.g. '100'
- 2) Followed by the multiplier if required e.g. 'k'
- 3) Followed by the function ' $\Omega$  2-Wire'
- 4) Then 'Enter' and 'Output ON'

<b>Key in Resistance Value</b>	<b>Select Multiplier</b>	<b>Select Function</b>	<b>Press Enter</b>	<b>Select Output On</b>

The resistance displayed will be the calibrated value held in the non volatile calibration memory for that standard. Note the values are different for two and four wire ohms.

### Nulling DMM

The calibrated values displayed for 2 wire ohms is the value present at the terminals. Therefore the measuring instrument should be zeroed (Nulled) with the leads shorted before connection to the calibrator.

## 2 Wire Ohms Operation

Two wire ohms is output on the voltage terminals as indicated by the terminal LED's.

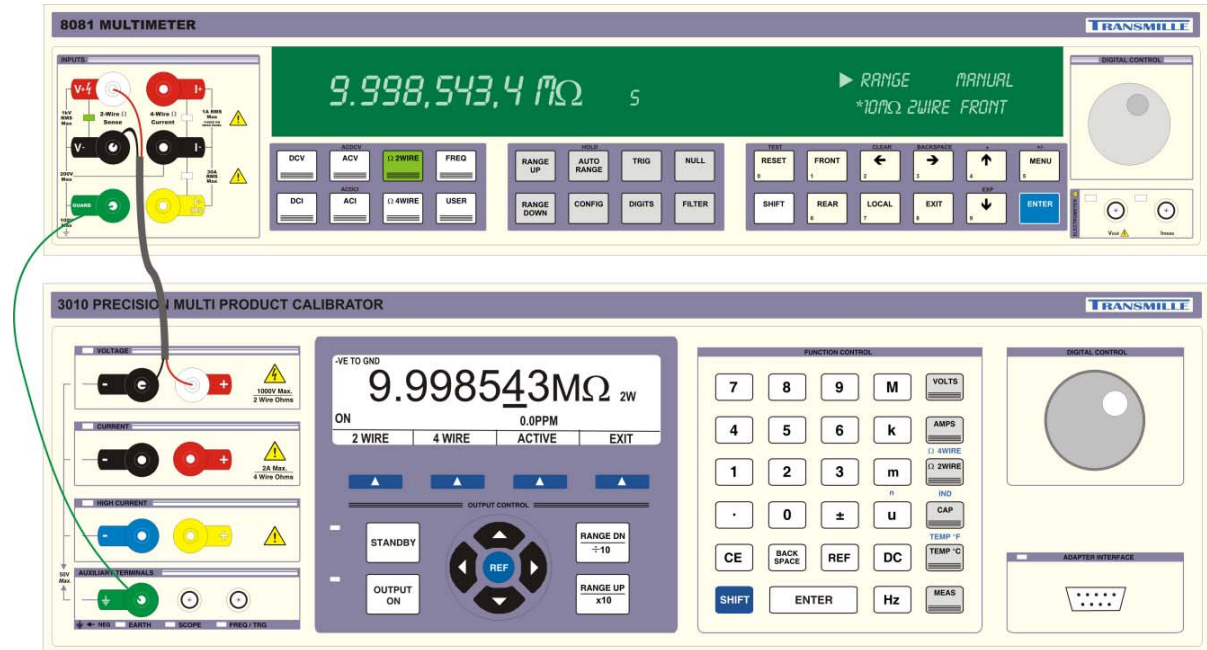

### 2 Wire Ohms Connection

Connect the measuring instrument 2-Wire input to the calibrator 2-Wire resistance output.

Use shielded connection cables – 50 Ohm co-axial recommended

Connect Guard / Earth if required – see notes

Select 2 Wire resistance measurement mode on meter

## Setting 4 Wire Resistance Output.

*Note* : The calibrator uses standard resistors of fixed decade values. The nearest available resistance to the entered value will be automatically selected. The example below selects 100mOhms in 4 wire mode.

- 1) Key in the required value, e.g. '100'
- 2) Followed by the multiplier if required e.g. 'm'
- 3) Press 'Shift' Key
- 4) Followed by the shift-function 'Ω 4-Wire'
- 5) Then 'Enter' followed by 'Output ON'

<b>Key in Resistance Value</b>	<b>Select Multiplier</b>	<b>Press Shift</b>	<b>Select 'Shift' Function</b>	<b>Press Enter</b>	<b>Select Output On</b>

The resistance displayed will be the calibrated value held in the non volatile calibration memory for that standard. Note the values are different for two and four wire ohms. Four wire ohms is indicated on the terminal LED's by both the voltage and current terminal LEDs illuminating.

### Nulling DMM

The calibrated values displayed for 4 wire ohms are the values referenced to the calibrator's zero position. Therefore, the measuring instrument should be zeroed (Nulled) with all 4 leads (top leads sense, lower leads current) connected to the calibrator with the zero ohms selected.

## 4 Wire Ohms Operation

Four wire ohms is output on the voltage and current terminals as indicated by the terminal LED's. Connect the 'sense' from the DMM to the voltage output on the calibrator, and connect the 'current' from the DMM to the calibrator current terminals.

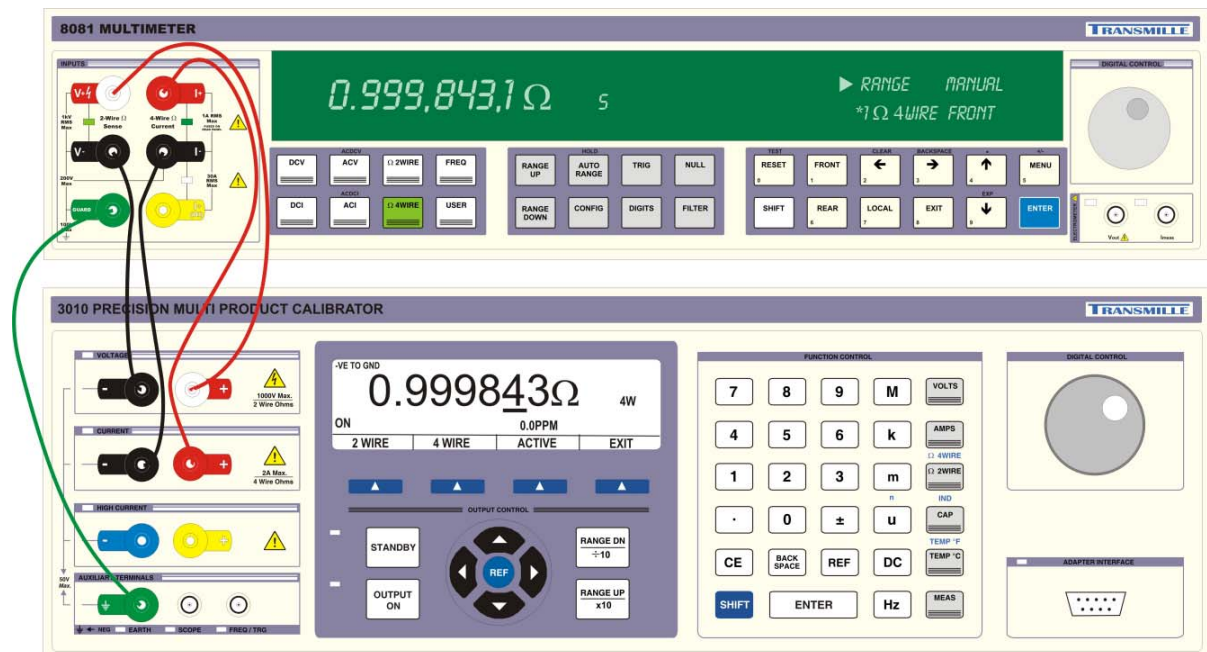

### 4 Wire Ohms Connection

Connect the measuring instrument 4-Wire input to the calibrator 4-Wire resistance output.

Use low thermal leads and connections

Connect Guard / Earth if required – see notes

Select 4 Wire resistance measurement mode on meter



## Setting Capacitance Output.

*Note* : The calibrator uses standard capacitors of fixed values. The nearest available capacitance to the entered value will be automatically selected. The example below selects 100nF.

- 1) Key in the required value, e.g. '100'
- 2) Followed by the multiplier if required e.g. 'u'
- 3) Followed by the function 'CAP'
- 4) Then 'Enter'

<b>Key in Capacitance Value</b>	<b>Select Multiplier</b>	<b>Select Function</b>	<b>Press Enter</b>	<b>Select Output On</b>

Capacitance is output from the voltage terminals as indicated by the LED.

The capacitance displayed will be the calibrated value held in the non volatile calibration memory for that standard.. Note this is the value measured with a 1kHz sine wave on a LCR bridge. When measuring capacitance, Cp (parallel) should be selected for values up to and including 1uF and Cs (series) for values above.

## Setting Inductance Output (Option)

*Note* : The calibrator uses standard inductors of fixed values. The nearest available inductance to the entered value will be automatically selected. The example below selects 10mH.

- 1) Key in the required value, e.g. '10'
- 2) Followed by the multiplier if required e.g. 'm'
- 3) Press 'Shift'
- 4) Followed by the function 'IND'
- 5) Then 'Enter'

<b>Key in Inductance Value</b>	<b>Select Multiplier</b>	<b>Press Shift</b>	<b>Select 'Shift' Function</b>	<b>Press Enter</b>	<b>Select Output On</b>

The inductance displayed will be the calibrated value held in the non volatile calibration memory for that standard.

## Thermocouple Simulation (Option).

### Thermocouple Adapter Connection

Using the supplied adapter connection lead (9 way 'D' type to 9 way 'D' type), connect the thermocouple adapter to the feature connection on the front panel of the 3000 series calibrator.

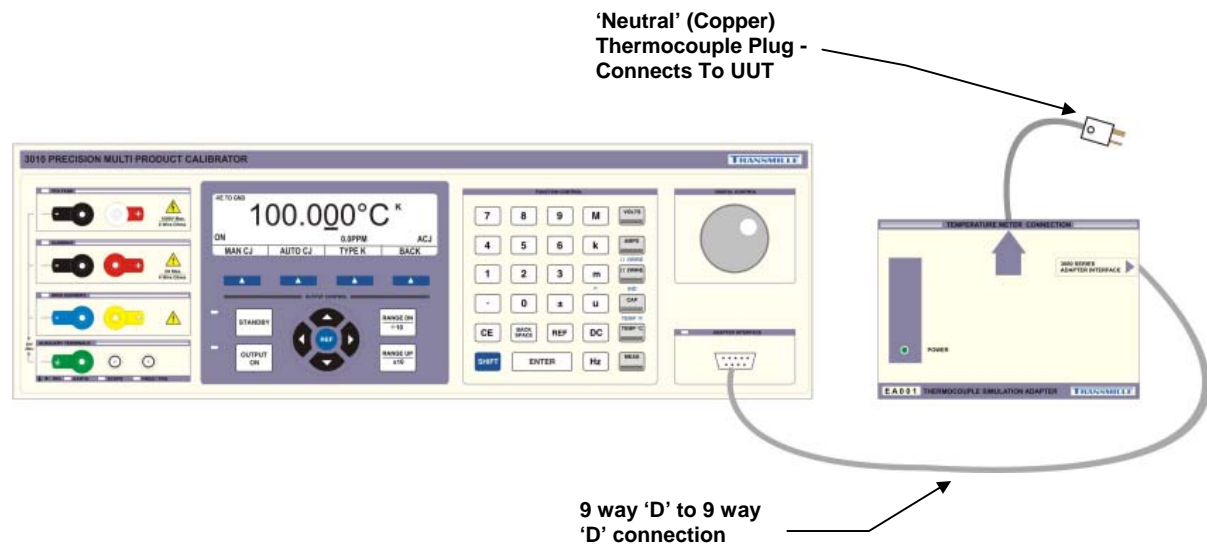

### Starting the Thermocouple Simulation Option

To start the thermocouple simulation option, press the softkey below the **THERMO C** menu item

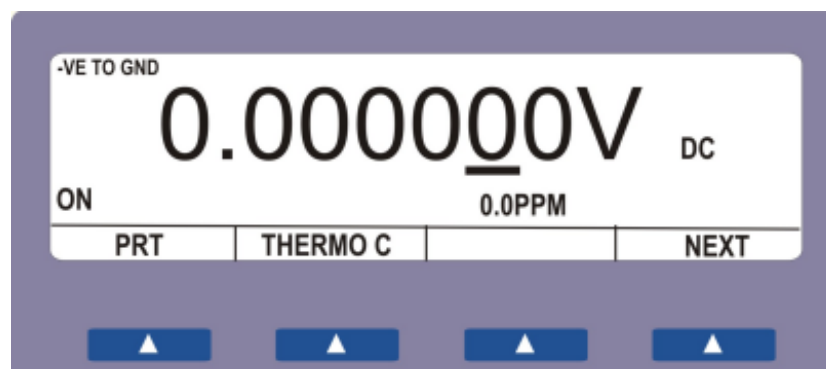

Thermocouple Mode softkey



#### TIP

If the **THERMO C** menu item is not displayed, press the **NEXT** softkey to go to the next menu level.

## Thermocouple Simulation Option Operation

The thermocouple simulation option allows the user to enter a temperature in °C and set the calibrator to the specific voltage output which corresponds to the thermocouple type selected. On entering thermocouple simulation mode, type K will be the default function. The display below will be shown indicating the currently selected range and output status :

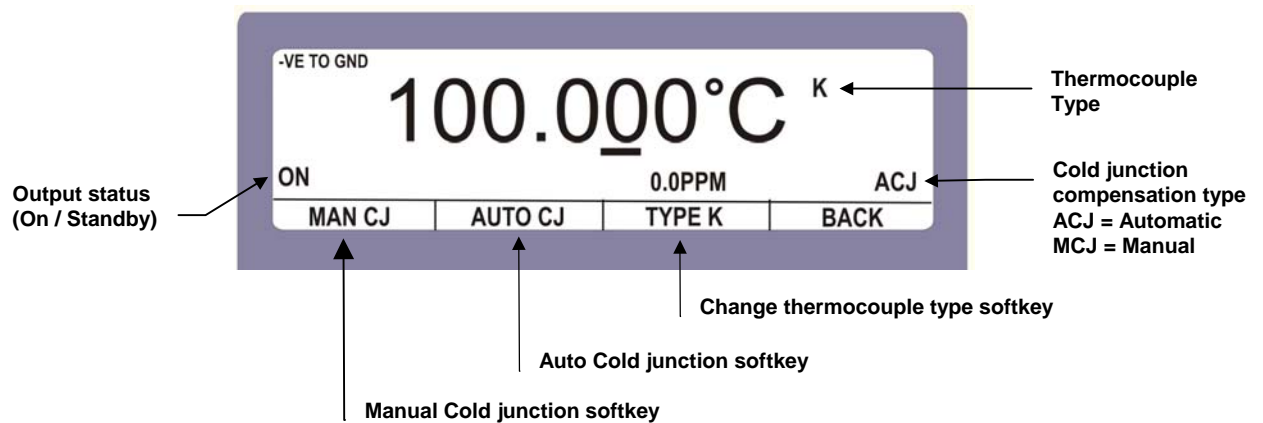

Once in thermocouple mode, the menus available at the bottom of the screen will change to reflect the thermocouple mode options - the available menu items are :

**MAN CJ** Selects the manual cold junction compensation mode  
This allows cold junction value to be set to zero.

**AUTO** Selects the automatic cold junction compensation mode  
This allows the calibrator to use the built in temperature sensor within the adapter's thermocouple plug to compensate for the cold junction measured between the adapter plug and the UUT socket.

**TYPE K** Selects the thermocouple type currently being simulated.  
Pressing this softkey allows the user to cycle through the available thermocouple types in the following order

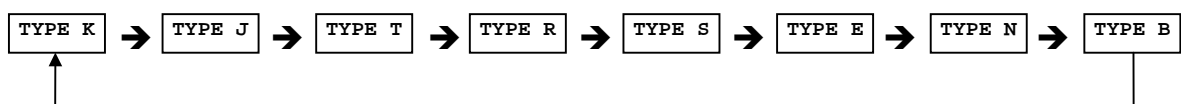

1. Connect the thermocouple simulation adapter to the 3000 Series calibrator via its feature connector using the supplied 9 way 'D' type to 9 way 'D' type lead. Connect the UUT to the thermocouple plug extending from the opposite end of the thermocouple simulation adapter. Set the UUT to the required range.

2. Select the thermocouple type to be simulated using thermocouple type selection softkey **TYPE K**

Pressing this softkey allows the user to cycle through the available thermocouple types in the following order :

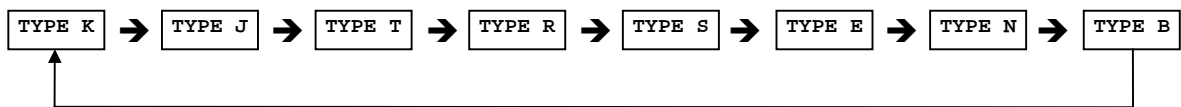

3. Select the cold junction setting using the softkeys :

**Manual Cold Junction Compensation** **MAN CJ**

Sets the cold junction to zero

**Automatic Cold Junction Compensation** **AUTO**

Activates the built in temperature sensor in the thermocouple plug to accurately compensate for the temperature at the point of connection.

4. Use the calibrator keypad to key in the required temperature, for example 450.5° :

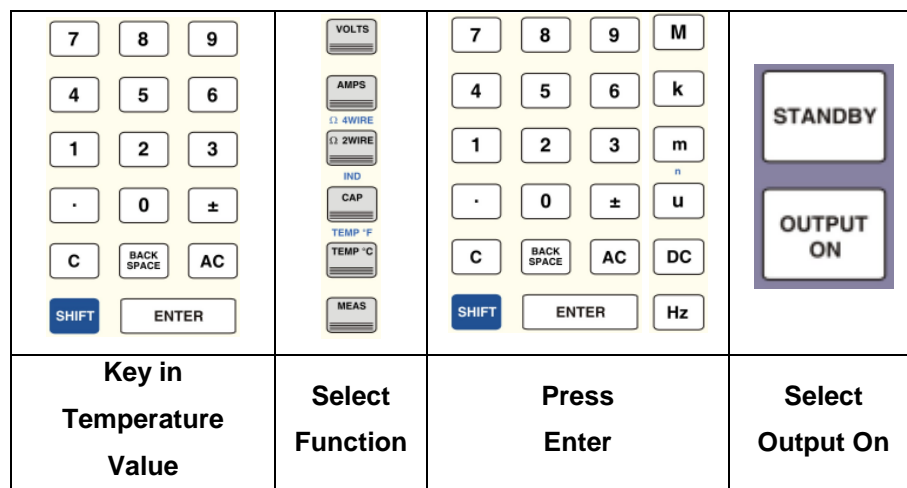

5. To deviate the temperature output from the nominal value, use the deviation function. This is controlled by using the left and right arrow keys to select the digit to be increased or decreased

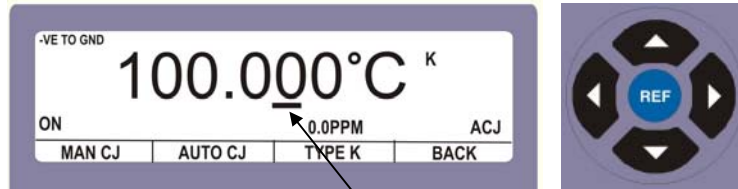

Use the left right arrows to highlight the digit to be adjusted (indicated by the underlined digit)

To increase or decrease the digit, simply use the up down keys on the calibrator's keyboard or use the digital potentiometer

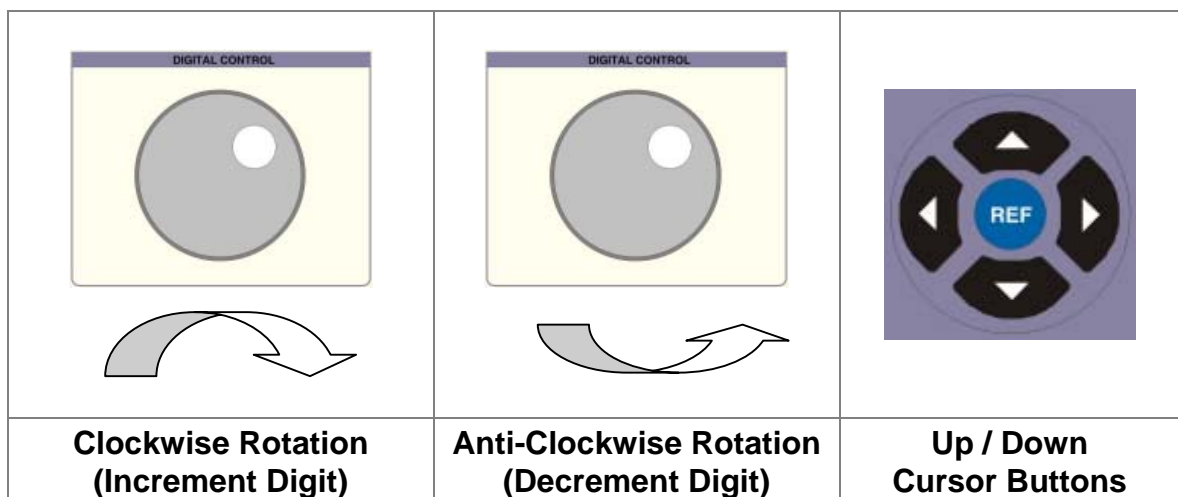

**Note :** The thermocouple type, temperature and cold junction compensation settings can be changed at any time by re-entering / selecting the setting required



**TIP**

Automatic or manual cold junction value is only updated when a temperature is entered or the output is set to standby, then on (i.e. to apply the change from automatic to manual cold junction, the output must be re-entered or the output set to *standby*, then to *output on*).

## Special Functions Available using the 'soft' keys

The 'soft' keys are positioned directly under the display and the function of these keys will change depending on the function of the calibrator. To enable scrolling down through menus **NEXT** will take you down one level and **BACK** return to the previous level. The functions available in these menus is detailed in the following paragraphs.

### Connecting Output Negative to line earth or floating

The soft key **-VE GND** in the menu switches the output from floating or connecting the negative side to Earth/ground. The 'on' condition is shown at the top left of the display '-VE GND' and also by the front panel LED. We recommend that the default condition of output earthed is used as this reduces noise and pick up on the output and also reduces the risk of damage to the calibrator by mis-connection.

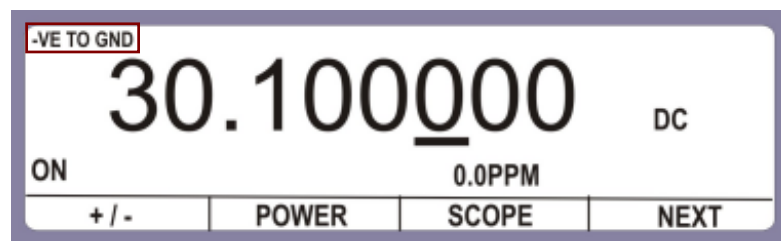

## Selecting front panel control

After the calibrator has been controlled from the interface, the front panel controls are disabled. To regain front panel control use the 'Local' soft key

## Setting TTL Logic Frequency Output.

Note : The calibrator uses a precision Temperature Compensated Crystal Oscillator (TCXO) and divider chain for this output with exact values available only.

- 1) Select **FREQ O/P** using the soft Keys.
- 2) Use up down arrow keys or the rotary control to select the required frequency.



PWM output is from the FREQ/TRG BNC terminal

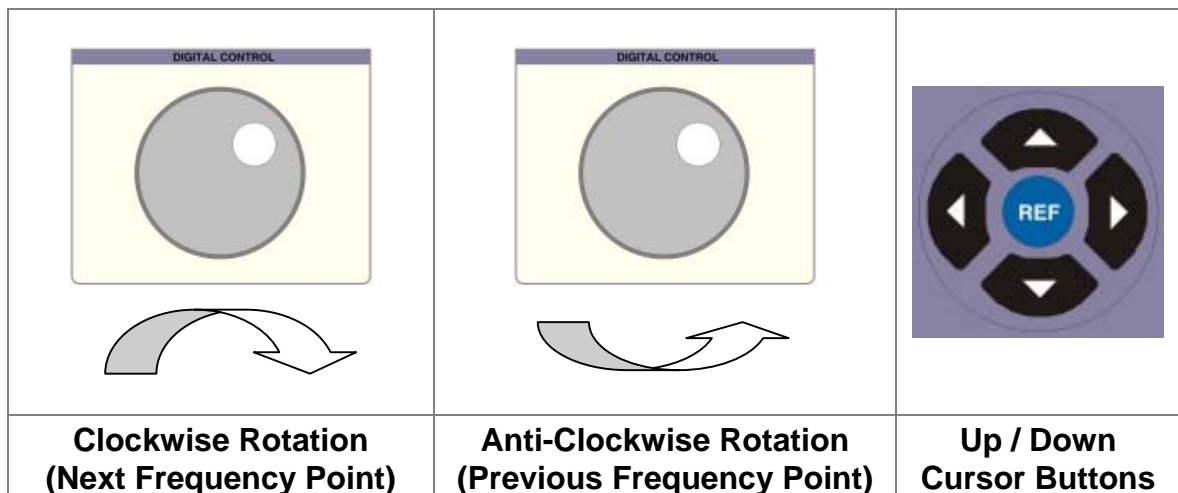
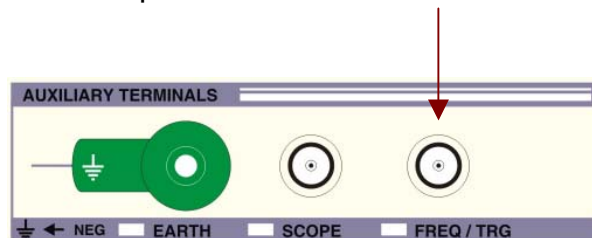



## Setting PWM (Mark Space Ratio)

The calibrator can produce an accurate mark space ratio output at approx. 1.23kHz at 20%, 40%, 60% and 80% intervals. These may be selected using the keyboard or the digital rotary control.

1. Select **PWM** From the soft menu
2. Use up down arrow keys or the rotary control to select the required Mark Space ratio.

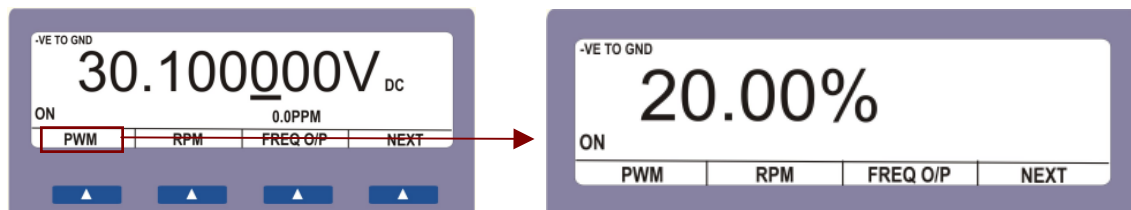

PWM output is from the FREQ/TRG BNC terminal

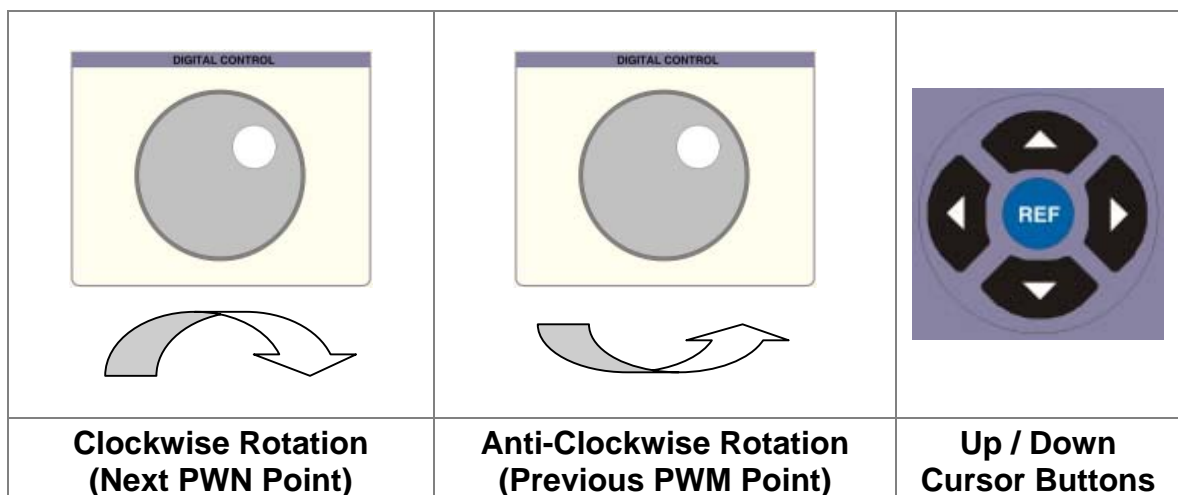
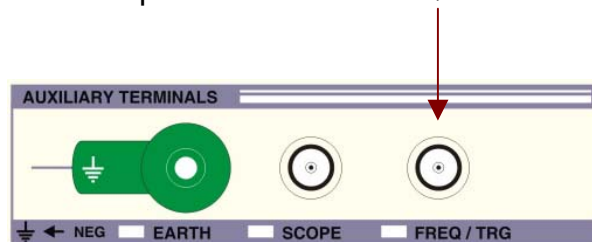

## Selecting PRT (PT100) Resistance Output (Option)

*Note* : The calibrator uses standard resistors of fixed values. The nearest available temperature to the entered value will be automatically selected.

- 1) Select **PRT** from the soft menu's
- 2) Use up / down arrow keys or the rotary control to select the required temperature.
- 3) Select Output ON to output resistance

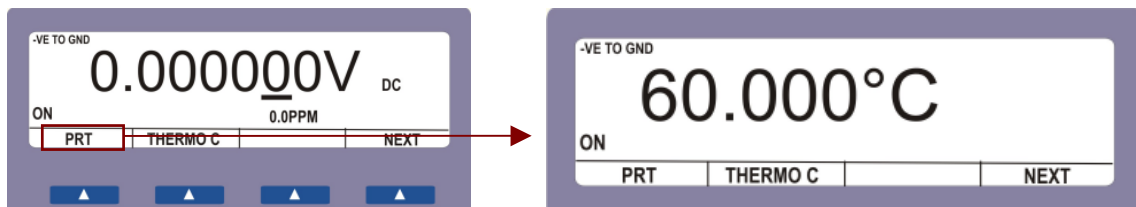

4 Wire output is from the Voltage & Current terminals

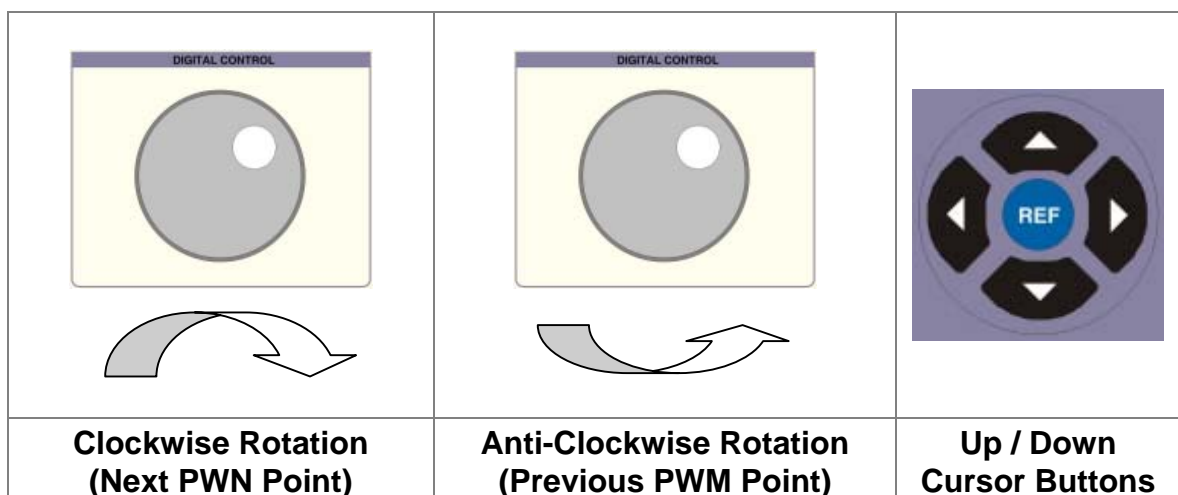

## Selecting AC Power Calibration Output (Option)

The Calibrator can simulate power by simultaneously outputting AC voltage and AC current with a phase relationship.

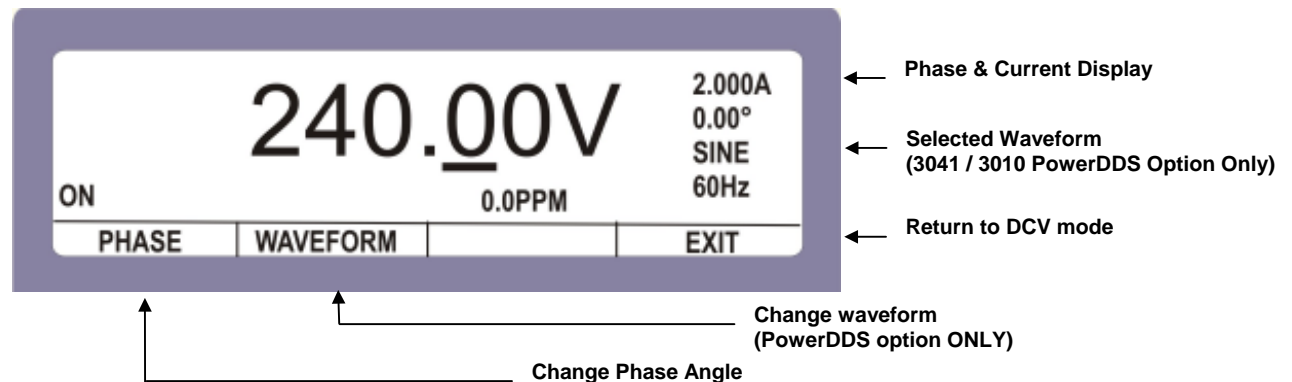

To configure power calibration mode :

- 1) Select 'POWER' function from the soft menu
- 2) Enter a voltage by keying in a number followed by V, then press ENTER, eg.
- 3) Enter a current in amps by keying in the value, followed by A

Note : *When entering current, pressing ENTER after the value is not required*

- 4) Enter a frequency in Hz by keying in the value, followed by Hz

<p><b>Key in Voltage</b> Select VOLTS Press ENTER</p>	<p><b>Key in Current</b> Select Amps</p>	<p><b>Key in Frequency</b> Select Hz Press ENTER</p>



Note : Current output in power mode follows the same convention as normal current operation –

Up to 2A is output from the low current terminals

2.02 – 30A (20A for 3050) output from the high current terminals

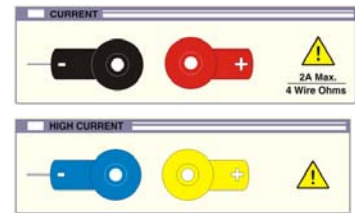

5) To change phase, select the phase menu item as shown previously

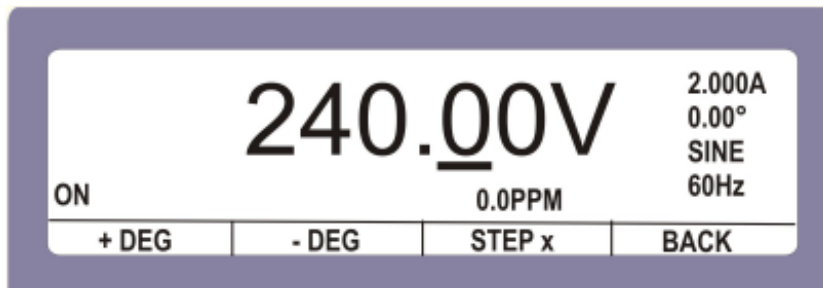

← Phase & Current Display  
 ← Selected Waveform (3041 / 3010 PowerDDS Option Only)  
 ← Return to DCV mode



Use **+ Deg** or **- Deg** to adjust the phase by the step size as indicated.

Use the **STEP** button to preset the phase adjust step size.

6) FOR POWER DDS Option ONLY

Use the Waveform button to select alternative waveforms – the waveforms available will cycle through on each push of the waveform button, as shown below. The CUSTOM waveform item is user programmable using the ProWave software supplied with the calibrator. See the ProWave documentation for more details on setting the custom waveform.

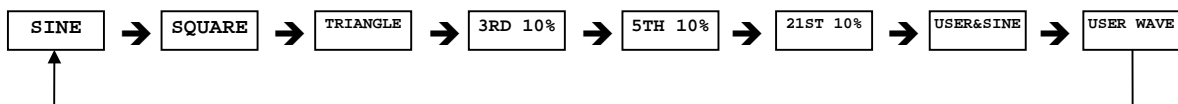

Use the Output On / Standby buttons to control the output



Note : When the hourglass is shown in the calibrator display, phase correction is in progress, and calibrator will not respond until completed and the hourglass icon disappears.

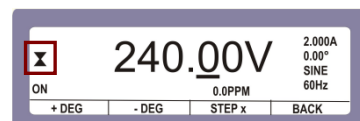

## Selecting DC Power Calibration Output (Option)

The Calibrator can simulate DC power by simultaneously outputting DC voltage and DC current.

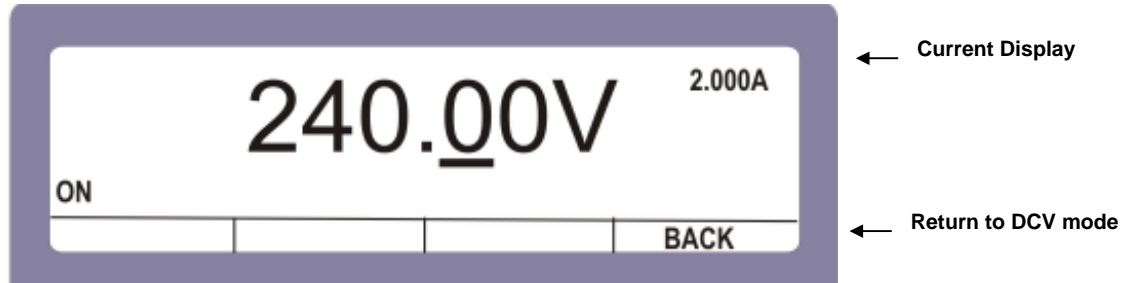

To configure power calibration mode :

- 7) Select 'POWER' function from the soft menu's
- 8) Enter a voltage by keying in a number followed by V, then press ENTER, eg.
- 9) Enter a current in amps by keying in the value, followed by A

Note : *When entering current, pressing ENTER after the value is not required*

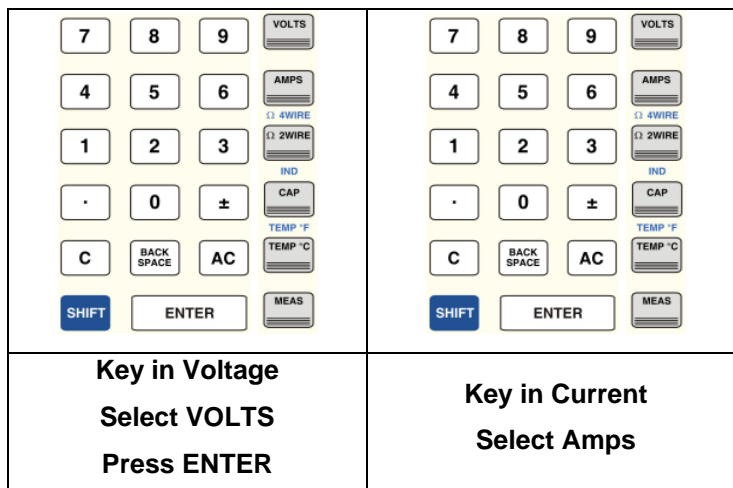

## Selecting Oscilloscope Calibration Output (Option)

The Calibrator can provide Amplitude, Timebase and Bandwidth outputs for calibration of oscilloscopes.

To configure oscilloscope calibration mode :

- 1) Select SCOPE function from the soft menu's
- 2) Calibrator will select TIMEBASE mode.

Use the RANGE UP or RANGE DOWN buttons to change range  
(eg. From 20ns/DIV, pressing range up will up range to the 50ns/DIV range)

To alter the deviation, use the up / down arrow buttons or digital control.

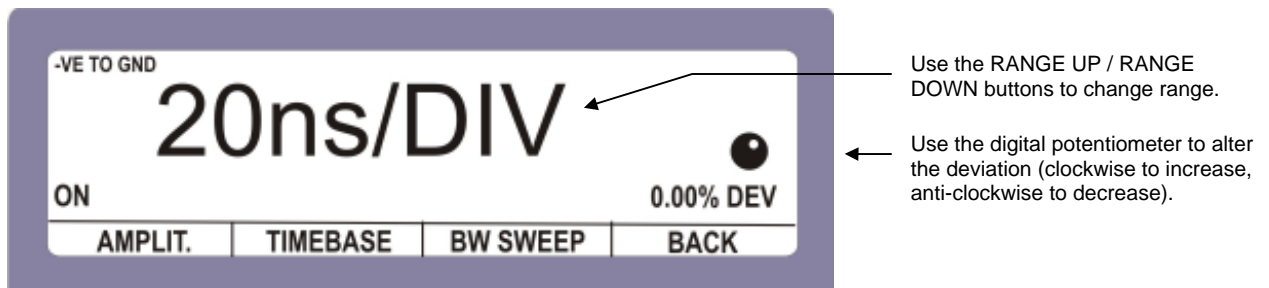

Use the RANGE UP / RANGE DOWN buttons to change range.

Use the digital potentiometer to alter the deviation (clockwise to increase, anti-clockwise to decrease).

3. For AMPLITUDE output, select the AMPLIT. Mode using the softkey.

To select a digit, use the left/right arrow buttons.

Use the RANGE UP or RANGE DOWN buttons to change range  
(eg. From 500mV/DIV, pressing range up will up range to the 1V/DIV range )

To change the output, use the up / down arrow buttons or use the digital potentiometer.

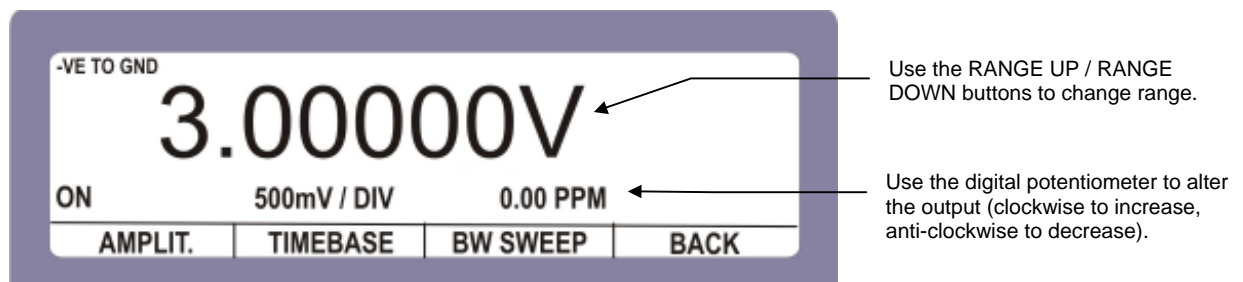

Use the RANGE UP / RANGE DOWN buttons to change range.

Use the digital potentiometer to alter the output (clockwise to increase, anti-clockwise to decrease).

4. For BW SWEEP output, select the BW SWEEP. Mode using the softkey.  
 To select a digit, use the left/right arrow buttons.  
 To change the output, use the up / down arrow buttons or use the digital potentiometer.

In BW Sweep Mode, the BW Sweep softkey menu item changes to BW REF.  
 This allows selection of the 50kHz bandwidth reference.

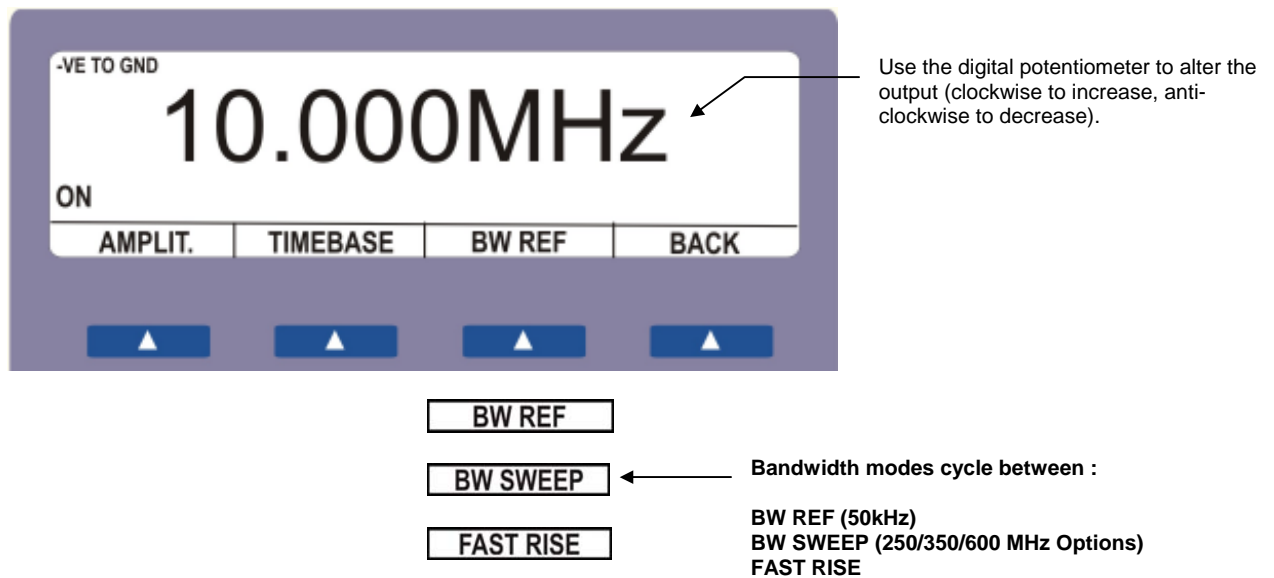

## Warning and output Overload indications.

The self test function of the 3000 series calibrator also continuously monitors the output of the calibrator of overload or fault conditions.

In the event of the calibrator not being able to drive the load, it will automatically trip into standby and the display will show **STBY !**. The 'standby' condition is caused by the required drive current being too high on a voltage range or the compliance voltage too high on a current range. The output can be restored by pressing the **Output On** key after the load has been corrected.

## High Voltage Timeout.

As an additional safety feature, the calibrator will automatically return to standby if left on the 200V or 1kV ranges after a set time period. This is 20 minutes for DC and AC frequencies of less than 5kHz or 3 minutes for frequencies of 5kHz and greater.

## 30 Amp Temperature Cut-out

The 3000 Series calibrators are capable of high current for sustained amounts of time up to 20A – above this value the calibrator will enter a standby / cool-down period after a set amount of time depending on the output set. The output amplifier operating temperature is monitored by the micro controller which will shut down the output if required. The time before shut down occurs will vary depending on the set output current and the load - see extended specifications. During this shutdown period, the calibrator will be set to standby with a warning message shown on the display **STBY !!**. It is safe to reselect the output at any time as the micro processor will automatically protect the output amplifier from damage.

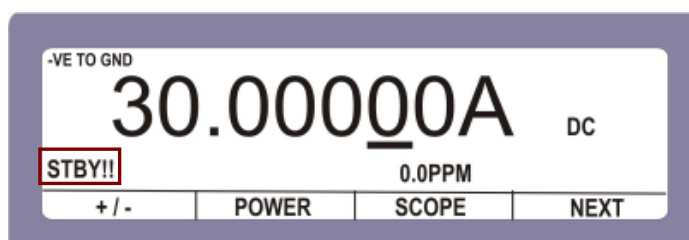



## **Interface Types**

---

Connection to the 3000 Series calibrators is achieved by the following interfaces :

### **■ RS232**

9 Way 'D' type female connection

### **■ USB (optional)**

USB connection using COM to USB conversion via a dedicated adapter

## RS232 Interface

---

The calibrator can be fully controlled and calibrated via the bi-directional RS232 interface. The interface uses the standard 9 pin PC connector and a standard serial lead. The interface is fully optically isolated from the rest of the calibrator circuitry. Baud rate is fixed at 9600 baud, no parity and one stop bit which allows a complete output command to be sent in less than 20ms. The calibrator can send to the computer information about the output status, calibration factors, value of internal standards together with other information. The internal processor decodes the commands and returns control codes to verify the correct operation of that command.

The calibrator can be sent individual commands directly from the Windows HYPER TERMINAL program, any basic or high level program, the virtual front panel program (if ordered), or from the ProCal Calibration System

### Configuring the COM port

To allow communication from PC based programs, these programs must be configured to the following settings :

**BAUD RATE : 9600**  
**PARITY : NONE**  
**DATA BITS : 8**  
**STOP BITS : 1**

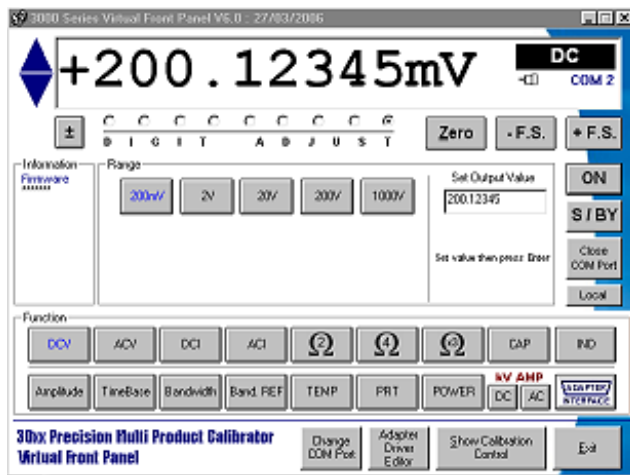

The 3000 series Virtual Front Panel software (optional) from Transmille comes pre-configured with these settings, however if you are using another program these settings will need to be verified before proceeding to control the 3000 Series calibrators.

The RS232 connection is made using a straight-through type cable - this is supplied as standard with any 3000 Series calibrator.



**DO NOT TRY TO USE A NULL MODEM TYPE CABLE AS THIS HAS PINS 2 & 3 REVERSED AND WILL NOT WORK.**

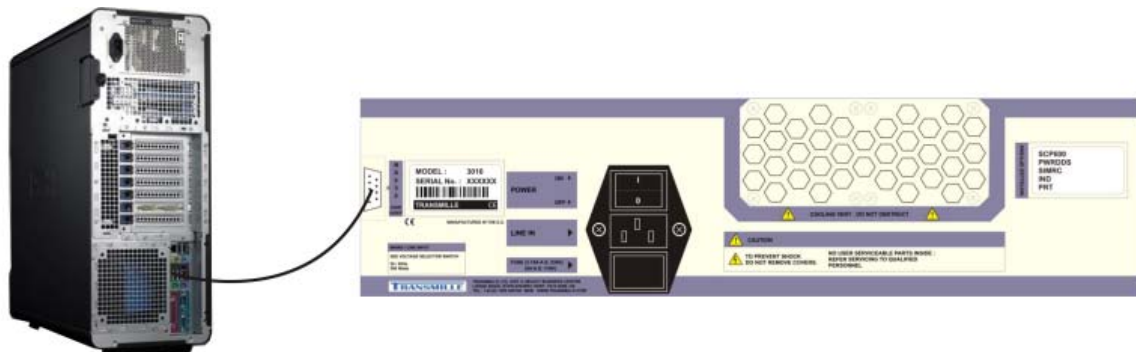

### 3000 Series to PC RS232 Connection

Connect the RS232 Interface from the 9 Way 'D' type connector on the rear of the PC to the 9 Way 'D' type connector on the 3000 Series calibrator.

## USB Interface

By using an RS232 to USB converter, the 3000 Series calibrators can be connected to the host PC via the USB port. This option will be provided as an additional compact unit and software driver.

The RS232 to USB converter will simulate a normal COM port (the next available free COM port number, usually COM3 upwards) - this is especially useful for newer type Laptop/Notebooks, where the traditional RS232 COM port has been replaced by one or more USB ports.

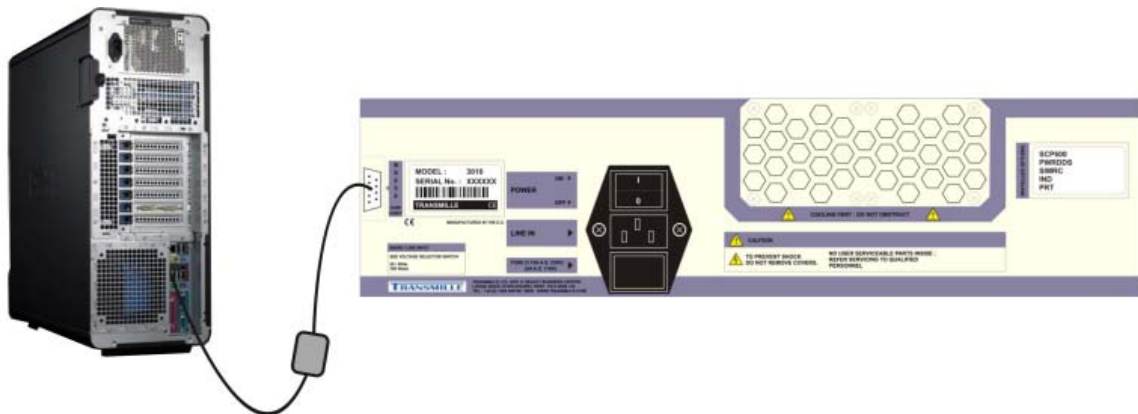

### 3000 Series to PC RS232 Connection

Connect the USB Interface from the USB type connector on the rear of the PC to the 9 Way 'D' type connector on the 3000 Series calibrator via the RS232 to USB converter.

---

## Remote Programming

---



### WARNING

The 3000 series calibrators can produce high voltages up to 1025V and must be programmed with due caution to prevent dangerous voltages from being output without warning to the operator.

Any programs should be extensively tested to maintain safe operation and include safeguard's such as error catchments and handling to ensure that any commands sent to the calibrator perform as expected and any that do not are safely handled to ensure user safety.

Within the 3000 series command language, response codes are included to determine the operational state of the calibrator. These response codes can also be used to determine whether a command was received correctly and in ensuring safe operation of the calibrator.

## **Programming Commands Overview**

---

The 3000 series is controlled by a set of simple high level commands which can be used either individually or as part of a command sequence to setup the 3000 Series calibrator to required state.

The commands can be joined together using the / (forward slash) character. The required terminator for the commands to be detected by the calibrator is a carriage return (ASCII character 13) and should be the last character sent on a command line

**For Example :**

**Command1/Command2 <CR>**

**Where each command is represented as Commandx**

**(x being the command number)**

**and the carriage return (ASCII character 13) is represented by <CR>**

## RESPONSE CODES

The 3000 Series calibrators will respond to any command with a fixed code beginning with an star (\*) - the codes are listed below

<b>Response Code</b>	<b>Description</b>
<b>*0</b>	<b>OK</b>
<b>*1</b>	<b>ERROR IN COMMAND LINE</b>
<b>*2</b>	<b>ERROR IN RANGE COMMAND</b>
<b>*3</b>	<b>ERROR IN FREQUENCY COMMAND</b>
<b>*4</b>	<b>ERROR IN O/P COMMAND</b>
<b>*5</b>	<b>ERROR IN CAL FACTOR SENT</b>
<b>*6</b>	<b>ERROR IN CAL FACTOR COMPARE</b>
<b>*7</b>	<b>COMMAND OUT OF RANGE ( A1,A2 ETC ) OR PASSWORD NOT SET</b>
<b>*8</b>	<b>10A/HV TIMEOUT or OVER TEMPERATURE</b>
<b>*9</b>	<b>OUTPUT ERROR</b>

## DC Voltage Commands

Function	Range	Command
DC Voltage	200mV	R1
	2V	R2
	20V	R3
	200V	R4
	1000V	R5

Standby Mode	
Standby ON	S1
Standby OFF	S0

Output	
Set Output	O (not zero)

The DC voltage section consists of a set of range commands which are used in conjunction with the standby and output command. To enable a DC Voltage to be set and an output assigned, the following command sequence should be used :

**<RANGE>/<OUTPUT>/<STANDBY CONDITION><CR>**

For example, to get 2V DC with the output switched on, the command is :

**R2/O2/S0<CR>**

**R2 = 2V Range (as detailed in the table above)**

**O2 = 2V Output**

**S0 = Standby OFF (i.e. output switched ON)**

**<CR> = Carriage Return (ASCII character 13)**



**Additional examples**

**150mV DC     R1/O150/S0<CR> (sets 150mV output on the 200mV range)**

**22V DC        R3/O22/S0<CR> (sets 22V output on the 200V range)**

If a command includes a value which cannot be set due to, for example, the value being higher than the range maximum, the calibrator will reject the command and stay set as it is (the calibrator will also beep to signify a rejected command)

The calibrator will respond to the commands sent with the response codes as detailed at the beginning of this section. These codes can be used to ensure that hazardous output conditions are clearly indicated to the operator and to maintain control of these outputs. This allows the calibrator to be returned to a safe state once the testing required has been completed (eg. Setting the calibrator back to standby once a test is complete and ensuring this has been successfully achieved and no hazardous outputs remain on the terminals).

This functionality is employed within the ProCal calibration software from Transmille to allow safe operation of the calibrator and to ensure the calibrator is returned to a safe state in between test points and at the completion of a test sequence.

## AC Voltage Commands

Function	Range	Command
AC Voltage	200mV	R12
	2V	R13
	20V	R14
	200V	R15
	1000V	R16

Standby Mode	
Standby ON	S1
Standby OFF	S0

Output	
Set Output	O (not zero)

AC Frequency	
Fxxxxx	E.G. 10kHz = F10000

The AC voltage section consists of a set of range commands which are used in conjunction with the standby and output command. To enable an AC Voltage to be set and an output assigned, the following command sequence should be used :

**<RANGE>/<OUTPUT>/<FREQUENCY>/<STANDBY CONDITION><CR>**

For example, to get 2V @ 200Hz AC with the output switched on, the command is :

**R2/O2/F200/S0<CR>**

**R2 = 2V Range (as detailed in the table above)**

**O2 = 2V Output**

**F200 = 200Hz Frequency**

**S0 = Standby OFF (i.e. output switched ON)**

**<CR> = Carriage Return (ASCII character 13)**

**Additional examples****135mV @ 10kHz AC R1/O135/F10000/S0<CR>****(sets 135mV @ 10kHz output on the 200mV range)****255V @ 15kHz AC R3/O255/F15000/S0<CR>****(sets 255V @ 15kHz output on the 1000V range)**

If a command includes a value which cannot be set due to, for example, the value being higher than the range maximum, the calibrator will reject the command and stay set as it is (the calibrator will also beep to signify a rejected command)

The calibrator will respond to the commands sent with the response codes as detailed at the beginning of this section. These codes can be used to ensure that hazardous output conditions are clearly indicated to the operator and to maintain control of these outputs. This allows the calibrator to be returned to a safe state once the testing required has been completed (eg. Setting the calibrator back to standby once a test is complete and ensuring this has been successfully achieved and no hazardous outputs remain on the terminals).

This functionality is employed within the ProCal calibration software from Transmille to allow safe operation of the calibrator and to ensure the calibrator is returned to a safe state in between test points and at the completion of a test sequence.

## DC Current Commands

Function	Range	Command
DC Current	200uA	R6
	2mA	R7
	20mA	R8
	200mA	R9
	2A	R10
	20A	R11

Standby Mode	
Standby ON	S1
Standby OFF	S0

Output	
Set Output	O (not zero)

The DC current section consists of a set of range commands which are used in conjunction with the standby and output command. To enable a DC current to be set and an output assigned, the following command sequence should be used :

**<RANGE>/<OUTPUT>/<STANDBY CONDITION><CR>**

For example, to get 20mA DC with the output switched on, the command is :

**R8/O20/S0<CR>**

**R8 = 20mA Range (as detailed in the table above)**

**O2 = 20mA Output**

**S0 = Standby OFF (i.e. output switched ON)**

**<CR> = Carriage Return (ASCII character 13)**

**Additional examples**

**25mA DC      R9/O25/S0<CR> (sets 25mA output on the 200mA range)**

**12A DC        R11/O12/S0<CR> (sets 12A output on the 20A range)**

If a command includes a value which cannot be set due to, for example, the value being higher than the range maximum, the calibrator will reject the command and stay set as it is (the calibrator will also beep to signify a rejected command)

The calibrator will respond to the commands sent with the response codes as detailed at the beginning of this section. These codes can be used to ensure that hazardous output conditions are clearly indicated to the operator and to maintain control of these outputs. This allows the calibrator to be returned to a safe state once the testing required has been completed (eg. Setting the calibrator back to standby once a test is complete and ensuring this has been successfully achieved and no hazardous outputs remain on the terminals).

This functionality is employed within the ProCal calibration software from Transmille to allow safe operation of the calibrator and to ensure the calibrator is returned to a safe state in between test points and at the completion of a test sequence.

## AC Current Commands

Function	Range	Command
AC Current	200uA	R17
	2mA	R18
	20mA	R19
	200mA	R20
	2A	R21
	20A	R22

Standby Mode	
Standby ON	S1
Standby OFF	S0

Output	
Set Output	O (not zero)

AC Frequency	
Fxxxxx	E.G. 10kHz = F10000

The AC current section consists of a set of range commands which are used in conjunction with the standby and output command. To enable a AC current to be set and an output assigned, the following command sequence should be used :

**<RANGE>/<OUTPUT>/<FREQUENCY>/<STANDBY CONDITION><CR>**

For example, to get 20mA @ 1kHz AC with the output switched on, the command is:

**R19/O20/F1000/S0<CR>**

**R19 = 20mA Range (as detailed in the table above)**

**O2 = 20mA Output**

**F1000 = 1kHz Frequency**

**S0 = Standby OFF (i.e. output switched ON)**

**<CR> = Carriage Return (ASCII character 13)**

**Additional examples****25mA @ 1.5kHz AC R20/O25/F1500/S0<CR>****(sets 25mA @ 1.5kHz output on the 200mA range)****12A AC @ 300Hz R22/O12/F300/S0<CR>****(sets 12A @ 300Hz output on the 20A range)**

If a command includes a value which cannot be set due to, for example, the value being higher than the range maximum, the calibrator will reject the command and stay set as it is (the calibrator will also beep to signify a rejected command)

The calibrator will respond to the commands sent with the response codes as detailed at the beginning of this section. These codes can be used to ensure that hazardous output conditions are clearly indicated to the operator and to maintain control of these outputs. This allows the calibrator to be returned to a safe state once the testing required has been completed (eg. Setting the calibrator back to standby once a test is complete and ensuring this has been successfully achieved and no hazardous outputs remain on the terminals).

This functionality is employed within the ProCal calibration software from Transmille to allow safe operation of the calibrator and to ensure the calibrator is returned to a safe state in between test points and at the completion of a test sequence.

## Resistance Commands

Function	Range	Command
Resistance	0 Ohms	R23
	0.1 Ohms	R24
	1 Ohms	R25
	10 Ohms	R26
	100 Ohms	R27
	1 kOhm	R28
	10 kOhms	R29
	100 kOhms	R30
	1 MOhms	R31
	10 MOhms	R32
	100 MOhms	R33
	1G Ohms	R65

Standby Mode	
Standby ON	S1
Standby OFF	S0

2 / 4 Wire Resistance	
2 Wire	I0
4 Wire	I1

The resistance section consists of a set of range commands which are used in conjunction with the 2 or 4 Wire mode and standby commands. To enable a DC resistance to be set, the following command sequence should be used :

**<RANGE>/<2 OR 4 WIRE MODE>/<STANDBY CONDITION><CR>**

The use of the output (O) command is not necessary as the resistance ranges are fixed ranges at decade points.



For example, to set the 1kOhm range 2-Wire output with the output switched on, the command is :

## **R28/I0/S0<CR>**

**R28 = 1KOhm Range (as detailed in the table above)**

**I0 = 2 Wire mode**

**S0 = Standby OFF (i.e. output switched ON)**

**<CR> = Carriage Return (ASCII character 13)**

### **Additional examples**

**1kOhm 4-Wire            R28/I1/S0<CR>**

**10Mohm 2-Wire        R32/I0/S0<CR>**

The calibrator will respond to the commands sent with the response codes as detailed at the beginning of this section. These codes can be used to ensure that hazardous output conditions are clearly indicated to the operator and to maintain control of these outputs. This allows the calibrator to be returned to a safe state once the testing required has been completed (eg. Setting the calibrator back to standby once a test is complete and ensuring this has been successfully achieved and no hazardous outputs remain on the terminals).

This functionality is employed within the ProCal calibration software from Transmille to allow safe operation of the calibrator and to ensure the calibrator is returned to a safe state in between test points and at the completion of a test sequence.

## Capacitance Commands

Function	Range	Command
Capacitance	1nF	R34
	10nF	R35
	20nF	R36
	50nF	R37
	100nF	R38
	1uF	R39
	10uF	R40
	100uF	R41

Standby Mode	
Standby ON	S1
Standby OFF	S0

The capacitance section consists of a set of range commands which are used in conjunction with the standby command. To enable a capacitance to be set, the following command sequence should be used :

**<RANGE>/<STANDBY CONDITION><CR>**

The use of the output (O) command is not necessary as the capacitance ranges are fixed ranges at decade points.

For example, to set the 10nF output with the output switched on, the command is :

**R35/S0<CR>**

**R28 = 10nF Range (as detailed in the table above)**

**S0 = Standby OFF (i.e. output switched ON)**

**<CR> = Carriage Return (ASCII character 13)**

## Simulated Resistance Commands (Option)

Function	Mode Activation Command		
Simulated Resistance	I2		
	Range	Command	Output
	10 Ohms – 99.9 Ohms	R27	Ohms
	100 Ohms – 999 Ohms	R28	kOhms
	1kOhms – 9.99kOhms	R29	kOhms
	10kOhms – 99.9kOhms	R30	kOhms
	100kOhms – 999kOhms	R31	MOhms
	1MOhms – 9.99MOhms	R32	MOhms

Standby Mode	
Standby ON	S1
Standby OFF	S0

Output	
Set Output	O (not zero)

The resistance section consists of a set of range commands which are used in conjunction with the standby command. To enable a capacitance to be set, the following command sequence should be used :

**<FUNCTION>/<RANGE>/<OUTPUT>/<STANDBY CONDITION><CR>**

Examples :

8kOhms	5MOhms	60 Ohms
I2/R29/O8/S0<CR>	I2/R33/O12/S0<CR>	I2/R27/O60/S0<CR>
I2 = Simulated Resistance Function R29 = 1kOhms – 9.99kOhms Range O8 = 8 Kohms Output S0 = Standby OFF (i.e. output ON) <CR> = Carriage Return (ASCII 13)	I2 = Simulated Resistance Function R32 = 1MOhms – 9.99 MOhms Range O5 = 5 MOhms Output S0 = Standby OFF (i.e. output ON) <CR> = Carriage Return (ASCII 13)	I2 = Simulated Resistance Function R27 = 10 Ohms – 99.9 Ohms Range O60 = 60 Ohms Output S0 = Standby OFF (i.e. output ON) <CR> = Carriage Return (ASCII 13)

150Ohms	500kOhms
I2/R28/O0.15/S0<CR>	I2/R31/O0.5/S0<CR>
I2 = Simulated Resistance Function R28 = 100 Ohms – 999 Ohms Range O0.15 = 0.15kOhms (150 Ohms) O/P S0 = Standby OFF (i.e. output ON) <CR> = Carriage Return (ASCII 13)	I2 = Simulated Resistance Function R31 = 100kOhms – 999kOhms Range O0.5 = 0.5MOhms (500kOhms) O/P S0 = Standby OFF (i.e. output ON) <CR> = Carriage Return (ASCII 13)

## Simulated Capacitance Commands (Option)

Function	Range	Command
Capacitance	100uF	R41
	1mF	R67
	10mF	R68

Standby Mode	
Standby ON	S1
Standby OFF	S0

The capacitance section consists of a set of range commands which are used in conjunction with the standby command. To enable a capacitance to be set, the following command sequence should be used :

**<RANGE>/<STANDBY CONDITION><CR>**

The use of the output (O) command is not necessary as the capacitance ranges are fixed ranges at decade points.

For example, to set the 1mF output with the output switched on, the command is :

**R41/S0<CR>**

**R41 = 100uF Range (as detailed in the table above)**

**S0 = Standby OFF (i.e. output switched ON)**

**<CR> = Carriage Return (ASCII character 13)**

**Additional examples****1mF            R67/S0<CR>****10mF          R68/S0<CR>**

The calibrator will respond to the commands sent with the response codes as detailed at the beginning of this section. These codes can be used to ensure that hazardous output conditions are clearly indicated to the operator and to maintain control of these outputs. This allows the calibrator to be returned to a safe state once the testing required has been completed (eg. Setting the calibrator back to standby once a test is complete and ensuring this has been successfully achieved and no hazardous outputs remain on the terminals).

This functionality is employed within the ProCal calibration software from Transmille to allow safe operation of the calibrator and to ensure the calibrator is returned to a safe state in between test points and at the completion of a test sequence.

## TTL Frequency Commands (Option)

Function	Mode Activation Command	
TTL Frequency	R58	
	Range	Command
	1Hz	H0
	10Hz	H1
	100Hz	H2
	1kHz	H3
	10kHz	H4
	20kHz	H5
	50kHz	H6
	100kHz	H7
	1MHz	H8
	10MHz	H9

Standby Mode	
Standby ON	S1
Standby OFF	S0

The TTL frequency section consists of a mode activation command followed by a set of range commands which are used in conjunction with the standby command. To enable a TTL frequency to be set, the following command sequence should be used :

**<MODE>/<RANGE>/<STANDBY CONDITION><CR>**

The use of the output (O) command is not necessary as the TTL frequency are fixed outputs

For example, to set the 10kHz output with the output switched on, the command is :

**R58/H4/S0<CR>**

**R58 = TTL Frequency Mode Activation (as detailed in the table above)**

**H4 = 10kHz output (as detailed in the table above)**

**S0 = Standby OFF (i.e. output switched ON)**

**<CR> = Carriage Return (ASCII character 13)**

**Additional examples**

**1Hz                R58/H0/S0<CR>**

**100kHz           R58/H7/S0<CR>**

The calibrator will respond to the commands sent with the response codes as detailed at the beginning of this section. These codes can be used to ensure that hazardous output conditions are clearly indicated to the operator and to maintain control of these outputs. This allows the calibrator to be returned to a safe state once the testing required has been completed (eg. Setting the calibrator back to standby once a test is complete and ensuring this has been successfully achieved and no hazardous outputs remain on the terminals).

This functionality is employed within the ProCal calibration software from Transmille to allow safe operation of the calibrator and to ensure the calibrator is returned to a safe state in between test points and at the completion of a test sequence.

## Pulse Width Modulation Commands (Option)

Function	Mode Activation Command	
Pulse Width Modulation	R59	
	Range	Command
	10%	H0
	20%	H1
	30%	H2
	40%	H3
	50%	H4
	60%	H5
	70%	H6
	80%	H7
	90%	H8

Standby Mode	
Standby ON	S1
Standby OFF	S0

The pulse width modulation section consists of a mode activation command followed by a set of range commands which are used in conjunction with the standby command. To enable a pulse width modulation to be set, the following command sequence should be used :

**<MODE>/<RANGE>/<STANDBY CONDITION><CR>**

The use of the output (O) command is not necessary as the pulse width modulation is configured for fixed outputs



For example, to set the 10% output with the output switched on, the command is :

**R59/H0/S0<CR>**

**R59 = Pulse width modulation Mode Activation (as detailed in the table above)**

**H0 = 10% output (as detailed in the table above)**

**S0 = Standby OFF (i.e. output switched ON)**

**<CR> = Carriage Return (ASCII character 13)**

**Additional examples**

**40%            R59/H3/S0<CR>**

**60%            R59/H5/S0<CR>**

The calibrator will respond to the commands sent with the response codes as detailed at the beginning of this section. These codes can be used to ensure that hazardous output conditions are clearly indicated to the operator and to maintain control of these outputs. This allows the calibrator to be returned to a safe state once the testing required has been completed (eg. Setting the calibrator back to standby once a test is complete and ensuring this has been successfully achieved and no hazardous outputs remain on the terminals).

This functionality is employed within the ProCal calibration software from Transmille to allow safe operation of the calibrator and to ensure the calibrator is returned to a safe state in between test points and at the completion of a test sequence.

## Inductance Commands (Option)

Function	Range	Command
Inductance	1mH	R42
	10mH	R43
	19mH	R44
	29mH	R45
	50mH	R46
	100mH	R47
	1H	R48
	10H	R49

Standby Mode	
Standby ON	S1
Standby OFF	S0

The inductance section consists of a set of range commands which are used in conjunction with the standby command. To enable a inductance to be set, the following command sequence should be used :

**<RANGE>/<STANDBY CONDITION><CR>**

The use of the output (O) command is not necessary as the inductance ranges are fixed ranges at decade points.

For example, to set the 29mH output with the output switched on, the command is :

**R45/S0<CR>**

**R45 = 29mH Range (as detailed in the table above)**

**S0 = Standby OFF (i.e. output switched ON)**

**<CR> = Carriage Return (ASCII character 13)**

**Additional examples****10mH          R43/S0<CR>****1H              R48/S0<CR>**

The calibrator will respond to the commands sent with the response codes as detailed at the beginning of this section. These codes can be used to ensure that hazardous output conditions are clearly indicated to the operator and to maintain control of these outputs. This allows the calibrator to be returned to a safe state once the testing required has been completed (eg. Setting the calibrator back to standby once a test is complete and ensuring this has been successfully achieved and no hazardous outputs remain on the terminals).

This functionality is employed within the ProCal calibration software from Transmille to allow safe operation of the calibrator and to ensure the calibrator is returned to a safe state in between test points and at the completion of a test sequence.

## PRT Commands (Option)

Function	Range	Command
PRT Value	-100°C	R50
	0°C	R51
	30°C	R52
	60°C	R53
	100°C	R54
	200°C	R55
	300°C	R56
	400°C	R57

Standby Mode	
Standby ON	S1
Standby OFF	S0

The PRT section consists of a set of range commands which are used in conjunction with the standby command. To enable a PRT value to be set, the following command sequence should be used :

**<RANGE>/<STANDBY CONDITION><CR>**

The use of the output (O) command is not necessary as the PRT ranges are fixed output ranges.

For example, to set the 60°C output with the output switched on, the command is :

## **R53/S0<CR>**

**R53 = 60°C Range (as detailed in the table above)**

**S0 = Standby OFF (i.e. output switched ON)**

**<CR> = Carriage Return (ASCII character 13)**

### **Additional examples**

**200°C            R55/S0<CR>**

**400°C            R57/S0<CR>**

The calibrator will respond to the commands sent with the response codes as detailed at the beginning of this section. These codes can be used to ensure that hazardous output conditions are clearly indicated to the operator and to maintain control of these outputs. This allows the calibrator to be returned to a safe state once the testing required has been completed (eg. Setting the calibrator back to standby once a test is complete and ensuring this has been successfully achieved and no hazardous outputs remain on the terminals).

This functionality is employed within the ProCal calibration software from Transmille to allow safe operation of the calibrator and to ensure the calibrator is returned to a safe state in between test points and at the completion of a test sequence.

## Thermocouple Simulation Commands (Option)

This function requires the use of the optional Thermocouple simulation adapter. This is used in conjunction with the feature connector on the 3000 Series to provide the thermocouple simulation.

Function	Mode Activation Command
Thermocouple Simulation	R60

Range	Command
Type K	L1
Type J	L2
Type T	L3
Type R	L4
Type S	L5
Type E	L6
Type N	L7
Type B	L8

Cold Junction	
Manual Cold Junction	K0
Auto Cold Junction	K1

Output	
Set Output	O (not zero)

Standby Mode	
Standby ON	S1
Standby OFF	S0

The thermocouple simulation function consists of the following commands :

- Thermocouple simulation mode activation
- Thermocouple cold junction type
- Thermocouple type command
- Thermocouple output value
- Standby mode command

To enable thermocouple simulation to be set up, the following command sequence should be used :

**<MODE>/<CJC TYPE>/<THERMO TYPE>/<TEMP VALUE>/  
<STANDBY CONDITION><CR>**

For example, to set the following configuration :

- **AUTOMATIC COLD JUNCTION COMPENSATION**
- **TYPE R**
- **250°C**
- **Output ON**

Send the following command sequence :

**R60/K1/L4/O250/S0<CR>**

**R60 = Thermocouple simulation mode activation**

**K1 = Automatic cold junction compensation (as detailed in the table above)**

**L4 = Type R thermocouple**

**O250 = 250°C output**

**S0 = Standby OFF (i.e. output switched ON)**

**<CR> = Carriage Return (ASCII character 13)**

**Additional examples**

**Type K : Auto CJC : 500°C = R60/K1/L1/O500/S0<CR>**

**Type K : Auto CJC : 1500°C = R60/K1/L1/O1500/S0<CR>**

**Type E : Manual CJC : 400°C = R60/K0/L6/O400/S0<CR>**

**Type N : Auto CJC : -100°C = R60/K1/L7/O-100/S0<CR>**

If a command includes a value which cannot be set due to, for example, the value being higher than the range maximum, the calibrator will reject the command and stay set as it is (the calibrator will also beep to signify a rejected command)

The calibrator will respond to the commands sent with the response codes as detailed at the beginning of this section. These codes can be used to ensure that hazardous output conditions are clearly indicated to the operator and to maintain control of these outputs. This allows the calibrator to be returned to a safe state once the testing required has been completed (eg. Setting the calibrator back to standby once a test is complete and ensuring this has been successfully achieved and no hazardous outputs remain on the terminals).

This functionality is employed within the ProCal calibration software from Transmille to allow safe operation of the calibrator and to ensure the calibrator is returned to a safe state in between test points and at the completion of a test sequence.



## Miscellaneous Commands

### Earth Relay (Floating or Grounded negative terminals)

Earth Relay	
<b>J0</b>	<b>Earth Relay On</b>
<b>J1</b>	<b>Earth Relay Off</b>

The earth relay command allows the negative terminals to either floating or grounded, depending on the command set. This is also indicated in the display of the calibrator by the -VE symbol (top left).

To set the negative terminals to floating, the command is :

**J1<CR>**

To set the negative terminals to grounded, the command is :

**J0<CR>**

<CR> = Carriage Return (ASCII character 13)

### Display Modes

Display Commands	
<b>!</b>	<b>Reverse Display Mode</b>
<b>b0</b>	<b>Set Backlight timeout to 5s</b>
<b>b1</b>	<b>Set Backlight timeout to 20 mins</b>
<b>b2</b>	<b>Set Backlight timeout to 2 hours</b>

Sending one of the above commands allow the display mode to be changed.

**! = Toggles between White on Black display or Black on White display modes**

## Oscilloscope Calibration Commands (Option)

This function requires the oscilloscope calibration option to be installed in the 3000 series calibrator - the output will appear on the BNC connector indicated by the green LED.

### Amplitude

Function	Mode Activation Command	
Amplitude Mode	A1	Amplitude Mode ON
	A0	Amplitude Mode OFF (returns to DCV mode)

Range	Command
5mV/DIV	H1
10mV/DIV	H2
20mV/DIV	H3
50mV/DIV	H4
100mV/DIV	H5
200mV/DIV	H6
500mV/DIV	H7
1V/DIV	H8
2V/DIV	H9
5V/DIV	H10
10V/DIV	H11
20V/DIV	H12
50V/DIV	H13

Amplitude Waveform	
Square Wave	G0
DC	G1

The Amplitude function consists of the following commands :

- **Amplitude mode activation**
- **Amplitude range**
- **Amplitude waveform**
- **Standby mode command**

To enable an amplitude range to be set up, the following command sequence should be used :

**<MODE>/<RANGE>/<WAVEFORM>/<STANDBY CONDITION><CR>**

For example, to set the following configuration :

- **1V/Div**
- **Square Wave**
- **Output ON**

Send the following command sequence :

**A1/H8/G0/S0<CR>**

**A1 = Oscilloscope amplitude mode activation**

**H8 = 1V/Div amplitude range**

**G0 = Square wave**

**S0 = Standby OFF (i.e. output switched ON)**

**<CR> = Carriage Return (ASCII character 13)**

**Additional examples****100mV/Div : Square Wave = A1/H5/G0/S0<CR>****10V/Div : DC = A1/H11/G1/S0<CR>**

The calibrator will respond to the commands sent with the response codes as detailed at the beginning of this section. These codes can be used to ensure that hazardous output conditions are clearly indicated to the operator and to maintain control of these outputs. This allows the calibrator to be returned to a safe state once the testing required has been completed (eg. Setting the calibrator back to standby once a test is complete and ensuring this has been successfully achieved and no hazardous outputs remain on the terminals).

This functionality is employed within the ProCal calibration software from Transmille to allow safe operation of the calibrator and to ensure the calibrator is returned to a safe state in between test points and at the completion of a test sequence.

## Timebase

Function	Mode Activation Command
Timebase Mode	R61

Range	Command
5s/DIV	H0
2s/DIV	H1
1s/DIV	H2
500ms/DIV	H3
200ms/DIV	H4
100ms/DIV	H5
50ms/DIV	H6
20ms/DIV	H7
10ms/DIV	H8
5ms/DIV	H9
2ms/DIV	H10
1ms/DIV	H11
500us/DIV	H12
200us/DIV	H13
100us/DIV	H14
50us/DIV	H15
20us/DIV	H16
10us/DIV	H17
5us/DIV	H18
2us/DIV	H19
1us/DIV	H20
500ns/DIV	H21
200ns/DIV	H22
100ns/DIV	H23
50ns/DIV	H24
20ns/DIV	H25

The Timebase function consists of the following commands :

- Timebase mode activation
- Timebase range
- Standby mode command

To enable a timebase range to be set up, the following command sequence should be used :

**<MODE>/<RANGE>/<STANDBY CONDITION><CR>**

For example, to set the following configuration :

- **1ms/Div**
- **Output ON**

Send the following command sequence :

**R61/H11/S0<CR>**

**R61 = Oscilloscope timebase mode activation**

**H11 = 1ms/Div timebase range**

**S0 = Standby OFF (i.e. output switched ON)**

**<CR> = Carriage Return (ASCII character 13)**

**Additional examples**

**1us/Div        = A1/H20/S0<CR>**

**50ns/Div      = A1/H24/S0<CR>**

The calibrator will respond to the commands sent with the response codes as detailed at the beginning of this section. These codes can be used to ensure that hazardous output conditions are clearly indicated to the operator and to maintain control of these outputs. This allows the calibrator to be returned to a safe state once the testing required has been completed (eg. Setting the calibrator back to standby once a test is complete and ensuring this has been successfully achieved and no hazardous outputs remain on the terminals).

This functionality is employed within the ProCal calibration software from Transmille to allow safe operation of the calibrator and to ensure the calibrator is returned to a safe state in between test points and at the completion of a test sequence.

## Bandwidth (Levelled) Sweep

Function	Mode Activation Command
BW Sweep Mode	R62

Output	
Set Output	O (not zero)

The bandwidth function consists of the following commands :

- **Bandwidth mode activation**
- **Output value (MHz)**
- **Standby mode command**

To enable a bandwidth to be set up, the following command sequence should be used :

**<MODE>/<OUTPUT VALUE>/<STANDBY CONDITION><CR>**

For example, to set 400MHz output with the output switched on, the command is :

**R62/O400/S0<CR>**

**R62 = Oscilloscope Bandwidth mode activation**

**O400 = 400MHZ output**

**S0 = Standby OFF (i.e. output switched ON)**

**<CR> = Carriage Return (ASCII character 13)**



**Additional examples**

**50MHz            = R62/O50/S0<CR>**

**600MHz         = R62/O600/S0<CR>**

If a command includes a value which cannot be set due to, for example, the value being higher than the range maximum, the calibrator will reject the command and stay set as it is (the calibrator will also beep to signify a rejected command)

The calibrator will respond to the commands sent with the response codes as detailed at the beginning of this section. These codes can be used to ensure that hazardous output conditions are clearly indicated to the operator and to maintain control of these outputs. This allows the calibrator to be returned to a safe state once the testing required has been completed (eg. Setting the calibrator back to standby once a test is complete and ensuring this has been successfully achieved and no hazardous outputs remain on the terminals).

This functionality is employed within the ProCal calibration software from Transmille to allow safe operation of the calibrator and to ensure the calibrator is returned to a safe state in between test points and at the completion of a test sequence.

## Bandwidth 50kHz Reference

Function	Mode Activation Command
BW Ref (50kHz)	R63

The bandwidth 50kHz reference function consists of the following commands:

- Bandwidth 50kHz mode activation
- Standby mode command

To select the 50kHz reference to be selected, the following command sequence should be used :

**<MODE>/<STANDBY CONDITION><CR>**

### **R63/S0<CR>**

**R63 = Oscilloscope Bandwidth 50kHz reference mode activation**

**S0 = Standby OFF (i.e. output switched ON)**

**<CR> = Carriage Return (ASCII character 13)**

The calibrator will respond to the commands sent with the response codes as detailed at the beginning of this section. These codes can be used to ensure that hazardous output conditions are clearly indicated to the operator and to maintain control of these outputs. This allows the calibrator to be returned to a safe state once the testing required has been completed (e.g. Setting the calibrator back to standby once a test is complete and ensuring this has been successfully achieved and no hazardous outputs remain on the terminals).

This functionality is employed within the ProCal calibration software from Transmille to allow safe operation of the calibrator and to ensure the calibrator is returned to a safe state in between test points and at the completion of a test sequence.

## Power Calibration Commands (Option)

This function requires the power calibration option to be installed in the 3000 series calibrator - the output will appear on the voltage and low current terminals and be indicated by the combined illumination of the voltage and low current terminal LEDs.



### UNDERSTANDING POWER

The equations below explain the relationship between Watts, Current, Voltage & Phase Angle.

Active Power :	$\text{Watts} = \text{Voltage} \times \text{Current} \times \text{Cosine 'Phase angle'}$
Apparent Power :	$\text{VA} = \text{Volts} \times \text{Current}$
Power Factor :	$\text{PF} = \text{Active Power} / \text{Apparent Power}$
Phase Angle :	$\text{F} = \text{Angle of AC Current shift from Voltage}$

Function	Mode Activation Command	
Power Mode	B1	Power Mode ON
	B0	Power Mode OFF (returns to DCV mode)

Voltage Setup	
Voltage output (volts)	O (not zero)

Current Setup	
Current output (amps)	C

Phase Setup	
Phase setting (degrees)	M

The power function consists of the following commands :

- Power mode activation
- Voltage output setting
- Current output setting
- Phase relationship in degrees
- Standby mode command

To enable a power output to be set up, the following command sequence should be used :

**<MODE>/<VOLTAGE>/<CURRENT>/<PHASE>/<STANDBY CONDITION><CR>**

For example, to set the following configuration :

- **200V**
- **2A**
- **90° Phase**
- **Output ON**

Send the following command sequence :

**B1/O200/C2/M90/S0<CR>**

**B1 = Power mode activation**

**O200 = 200V voltage output**

**C2 = 2A current output**

**M90 = 90° phase relationship**

**S0 = Standby OFF (i.e. output switched ON)**

**<CR> = Carriage Return (ASCII character 13)**

Additional example**B1/O500/C10/M180/S0<CR>**

**B1** = Power mode activation

**O500** = 500V voltage output

**C10** = 10A current output

**M180** = 90° phase relationship

**S0** = Standby OFF (i.e. output switched ON)

**<CR>** = Carriage Return (ASCII character 13)

If a command includes a value which cannot be set due to, for example, the value being higher than the range maximum, the calibrator will reject the command and stay set as it is (the calibrator will also beep to signify a rejected command)

The calibrator will respond to the commands sent with the response codes as detailed at the beginning of this section. These codes can be used to ensure that hazardous output conditions are clearly indicated to the operator and to maintain control of these outputs. This allows the calibrator to be returned to a safe state once the testing required has been completed (eg. Setting the calibrator back to standby once a test is complete and ensuring this has been successfully achieved and no hazardous outputs remain on the terminals).

This functionality is employed within the ProCal calibration software from Transmille to allow safe operation of the calibrator and to ensure the calibrator is returned to a safe state in between test points and at the completion of a test sequence.

Using the optional virtual front panel software from Transmille, additional functionality can be achieved from the power function including energy tests in kWh.

---

# Technical Description

---

## General

---

The series 3000 calibrators use the latest in reference, resistor and processor technology designed to minimise cost and size yet maximise performance. The micro processor controls and monitors all functions of the calibrator. Calibration constants are held in non volatile memory allowing the calibration to be performed without removing the covers. There are no internal adjustments required in normal service.



**Warning risk of shock.**

**The line power cord must be disconnected before opening the instrument**

The circuitry comprises of six printed circuit boards :

- Processor board
- Power supply and output switching board
- Main analogue amplifier and feedback board
- Reference and D/A board.
- Front Panel Display and keyboard control
- Mother PCB.

## Construction

---

The calibrator is constructed in a 3U 19" case with fan cooling used for the high voltage and high current amplifiers. The calibrator is construction is modular to allow ease of servicing. The rear panel assembly comprises of the mains inlet and transformer, 30 Amp power output amplifier and fan assembly.

The main analogue PCB slides in from the rear in slots in the inside of the case and plugs into the mother board which is mounted just behind the front panel. The precision reference and D/A converter plugs into the analogue PCB.

The Power supply and switching PCB plugs in to the mother board just above the analogue PCB. The Processor board plugs into this PCB.

---

## Internal Fuses.

---

In normal operation these fuses should never need to be replaced. Only under fault conditions will they require changing.

*NOTE* : To access these fuses it is necessary to dismantle the case which should only be carried out by an engineer. See removing top cover.



**Warning risk of shock.**

**The line power cord must be disconnected before opening the instrument**

**Internal fuses include :**

**F1 : ± 15V Supply     A/S 5Amp 20mm**

**F2 : ± 15V Supply     A/S 5Amp 20mm**

**F3 : ± 35V Supply     A/S 1Amp 20mm**

**F4 : ± 35V Supply     A/S 1Amp 20mm**



## Opening The Case

**!** *Warning risk of shock.*

**The line power cord must be disconnected before opening the instrument**

To gain access to the inside first remove the top cover by removing 6 screws located on the underneath of the calibrator. Carefully draw the rear panel straight back away from the instrument. Note the back panel assemble is heavy with the weight of the mains transformer etc. There are cable assemblies running from the rear panel sub assemble to PCB inside, these cables can be unplugged if required.

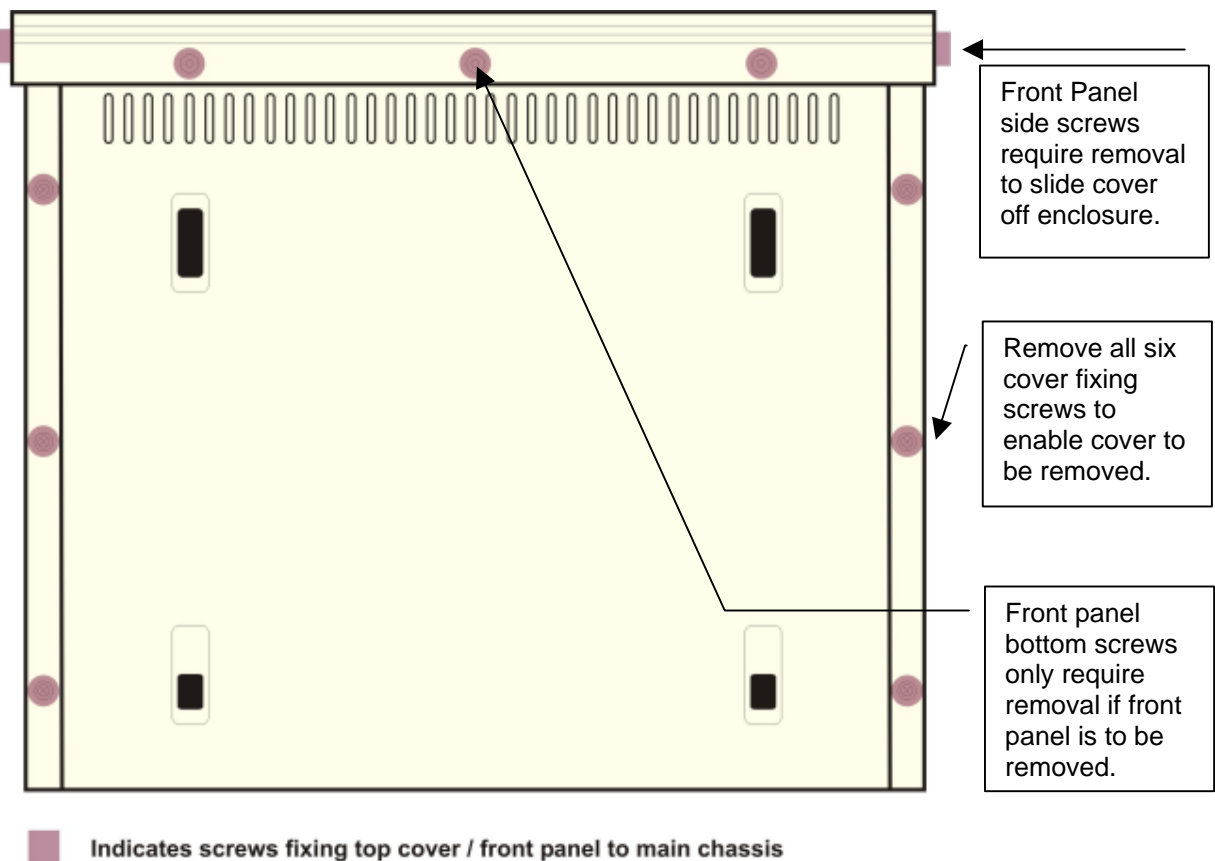

To allow the top cover to be slid back the two side screws must be removed (note the front panel has 3 fixings at the bottom of the panel – these only need to be removed if the front panel needs to be dropped down or removed).

---

## Access to Internal Fuses – Top PCB

---

After removing the top cover (see above) the metal screening cover of the top PCB must be removed – remove all nylon fixing screws, plus 1 metal screw from far end of PCB cover. The fuses will then be clearly visible (see below) :



**Fuses F1, F2, F3, F4  
located here :**

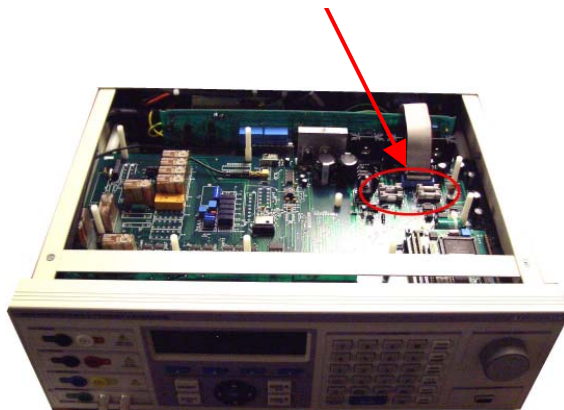

---

## Access to Internal Fuses – Front Panel PCB

---

Output protection fuses are located on the front panel PCB. To gain access to these, it is necessary to drop the front panel down – before proceeding, ensure the bottom 3 screws attaching the front panel to the main case are removed (see previous instructions for removing the top cover)

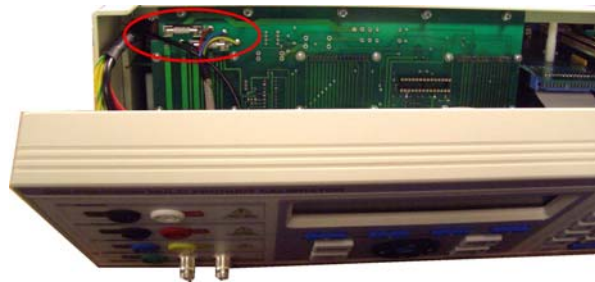

To allow the front panel to be dropped down for access to the front panel fuses, remove the screws from both sides of the front panel assembly, shown above. The fuses are located in PCB mounted fuse holders as shown above, right. Replace these fuses with the same type and rating – 2A Ultra Rapid

---

## Power supply and output switching board

---

On this board is the power supply for the calibrator which is a linear design having the inherent advantage of being low in noise. Supply voltages are  $\pm 5$  Volts,  $\pm 15$  Volts,  $\pm 35$  Volts and unregulated  $\pm 9$  Volts at 30Amps.

The resistance, capacitance and inductance standard also on this PCB which are selected by high performance relays. The resistance outputs can be selected as 4 wire from the program if selected.

---

## Processor Board

---

Plugs into the Power supply and output switching board and controls all functions within the calibrator with the exception of the high voltage safety cut-out. The processor board is a complete working board containing RAM, PROM, Clock, Cal Ram, I/O and RS232. The processor also applies all calibration factors held in RAM. Cal Factors are stored twice to prevent errors. The processor runs a self test to detect malfunction and overloads.

**Warning**

**Removal of the processor board may result in corruption of the calibration constants stored.**

## **Main analogue amplifier and feedback board**

---

This board generates AC and DC voltages and currents which are derived from the D/A boards 0 to 10Volt reference. This reference voltage is compared against the output after it is scaled from either a precision resistive divider or switchable gain for voltage ranges or from a set of precision current shunts for the current ranges. The error signal is amplified to produce the output. To maximise stability there are no adjustment components in the attenuator circuits, all calibration uses correction calibration factors stored in the non-volatile memory of the processor.

AC outputs are produced using digital signal processing to produce an accurate stable low distortion sine wave. The amplitude of this waveform is controlled by the difference signal from the DC Reference from the D/A and the DC output from a high performance true RMS converter.

## **High Voltage Amplifier and Output**

---

All outputs above 20 volts use this amplifier. A high power 150W IC amplifier running from 25 volt supplies with thermal and output overload protection output is switched into either a high frequency ferrite transformers or a LF iron laminate transformer depending on the frequency to produce all high voltage outputs. For DC outputs the signal is first chopped to provide an AC square wave at approx. 10kHz before being fed to the Power amp. The output from these transformers is rectified to produce a DC output or used directly for AC. A safety cut out circuit in the secondary windings of the transformers will disconnect the input to the amplifier in the event of excessive output current. This cut out is independent of processor control and once tripped will remain in an off state until reset by the processor. All high voltage switching is performed by relays. To maximise contact life relays are only operated when the amplifier is in standby.

## **Current Transconductance Amplifier**

---

A low voltage high current amplifier is used for current outputs powered from the unregulated 9 volt 30 amp supply. A pair of high power transistors on the heat sink before the fan are the final output stage of this amplifier. The output from this stage is switched to either the low current output terminals or the 30 amp output terminals.

## **Output Currents Sensing & Shunts**

---

Six high stability current shunts with low temperature coefficients from 4kOhms to 0.01ohm provide feedback for the current ranges. The lower values are switched using a four wire method for optimum accuracy, there is no provision for the adjustment of the value of the shunts, calibration is performed by the calibration factors. The 30Amp range shunt is mounted on the heat sink assembly on the rear panel.

Output from the shunts is fed to a low drift differential amplifier which is used to reference the current shunts output to system ground. Analogue switches set the transconductance amplifier to standby when range changing and when on voltage ranges. This prevents high current spikes being produced during range changing.

## **Calibration Tutorial**

---

### **Getting the best out of the calibrator.**

---

The 3000 series are very accurate calibrators producing a very wide range of output signals. To make the best possible use of the range of outputs and to eliminate errors this section details some common sources of errors and offers some techniques to reduce them.

#### **Thermally generated EMF voltage errors.**

---

At every connection in a measuring system different metals come into contact with each other, each junction forms a thermocouple. The voltages generated at these junctions are called thermoelectric voltages and are dependent on the type of metals in contact and the difference in temperature.

This effect, of course, is used to measure temperature with thermocouples, however this effect will cause large errors in low voltage measurements, as thermocouple voltages for some metals can be in the millivolt region. Copper is best but many standard test plugs are made from nickel plated brass and should not be used.

Gold plated copper plugs are available for low level work. If the test lead has been in use on a high current range this will have made the plug warm, which will also increase the error.



## **Power line and low frequency Pick up and noise**

---

These effects are most noticeable when using high resistance (100kohms and above) and low current. All constant current sources have a very high output impedance which will pick up noise just like the high value resistance . To reduce pickup, use screened leads and try earthing the low side of the calibrator output.

For high value resistance it is essential that the cables insulation resistance will not effect the accuracy. Most PVC cables will only have insulation resistance of around 10G $\Omega$ , this will give a error of 1% on the 100mohm output.

Low AC Current is particularly difficult as the capacitance of screened leads will shunt some of the current away.

---

## Calibration and Maintenance

---



### **WARNING**

**The information in this section is intended only for qualified personnel. The user must at all times be adequately protected from electric shock.**

---

### **General**

The 3000 series calibrators maintenance requirements are listed below. Please note that the calibrator does not require any regular internal servicing or adjustment.

- 1) Electrical Safety Checks on Line power lead and case**
- 2) Cleaning of the Fan**
- 3) Cleaning the external case**
- 4) Calibration and operation verifications**

---

### **Electrical Safety Tests**

These can be carried out as frequently as required. Earth bond and insulation can be tested as a class 1 standard. Flash testing is not recommended due to the possibility of damage to internal components. .

## Cleaning of the Fan Duct

---



### **WARNING : Risk of Shock**

**Ensure calibrator is disconnected from line power before proceeding.**

Fan ducts may be cleaned with brush and vacuum cleaner

## Cleaning the external case

---

Use a damp cloth with a mild water based cleaner for the outside case and front panel. Do not use alcohol based cleaners or solvents and do not spill or allow liquid to enter the case.

## Calibration

To adjust the 3000 Series calibrator the calibrator can either be connected to a computer via the RS232 Serial interface. Calibration constants stored within the calibrator can then be adjusted using the 3000 Series Virtual Front Panel software. To prevent unauthorised use of this software, a password is required before access is granted. Adjustment can be completed without disassembly of the calibrator.

The 3000 Series calibrator also includes the facility to adjust outputs using the front panel controls. Calibration constants stored within the calibrator can then be adjusted



**WARNING : Risk of Shock**

THIS PROCEDURE SHOULD ONLY BE ATTEMPTED BY QUALIFIED PERSONNEL

Each function e.g. DC voltage, AC Current, Resistance etc. has several ranges. Each range has one or more calibration constants. See table below.

The 3000 Series Font Panel allows any calibration constant to be adjusted independently of any other, therefore it is possible to adjust a single range without needing to adjust any other points. Altering the calibration constants directly changes the calibrators output. Adjusting the calibrator simply involves changing the constant until the output reads correctly.

<b>DC Voltage</b>	<b>: Zero : + Full Scale : - Full Scale</b>
<b>AC Voltage</b>	<b>: Zero : Full Scale @ 206Hz : Frequency Response</b>
<b>DC Current</b>	<b>: Zero : + Full Scale : - Full Scale</b>
<b>AC Current</b>	<b>: Zero : Full Scale @ 206Hz : Frequency Response</b>
<b>Resistance</b>	<b>: 2 Wire &amp; 4 Wire value for each resistance</b>
<b>Capacitance</b>	<b>: Value for each Capacitor</b>
<b>Inductance</b>	<b>: Value for each Inductor</b>

Linearity is inherent within the design of the D to A in the calibrator and does not require adjustment.

## Equipment Required

---

- **Precision 8 ½ Digital Multimeter.**  
Eg. Transmille 8081, Hewlett Packard HP3458A or Wavetek 1281.
- **Capacitance / Inductance bridge.**  
Eg. Wayne Kerr B905.
- **Frequency counter.**
- **Shunt resistors for measurement of 2A and 30A**  
(Not required for Transmille 8081)
- **Low thermal test leads with 4mm plug terminations.**
- **Shrouded test leads suitable for 1000V AC measurements.**
- **1m BNC to BNC cable with 2off BNC to 4mm adapters.**
- **Computer with RS232 interface running Transmille virtual front panel program.**
- **RS232 cable.**

## Adjustment Overview Using PC Virtual Front Panel Software

---

- 1) **Install virtual front panel software.**
- 2) **Connect 30xx to computer RS232 port**
- 3) **Allow all equipment to stabilise for at least 4 hours.**
- 4) **Run virtual front panel program.**
- 5) **Select range & output to be adjusted using the virtual front panel program.**
- 6) **Enter calibration control mode. (Password required).**
- 7) **Press 'Start' to enable adjustment. A 'C' will appear on the calibrator display.**
- 8) **Adjust calibration constant until the output of the calibrator is correct. The constants for each range must be adjusted in the correct sequence. See following pages for details.**
- 9) **Press the store button to save the constant**  
(Changing range will also store the constant.)

- 10) Press the 'abort' button to abandon changes for the range being adjusted.
- 11) Select next range to be adjusted.
- 12) Close calibration control panel and exit virtual front panel program

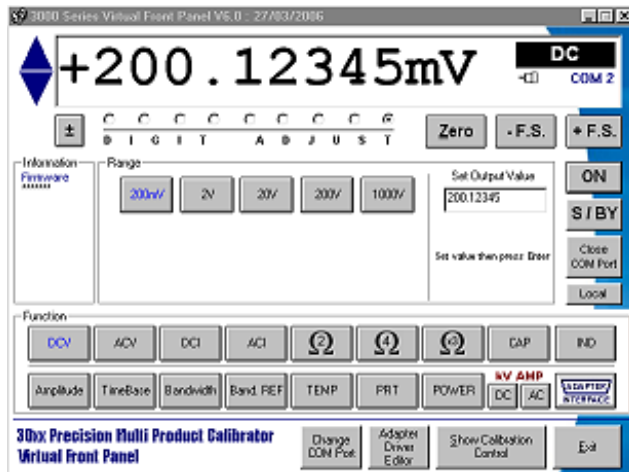







Comprehensive details of the calibration sequence are available in the 3000 Series Service Manual.

## Adjustment Overview Using Calibrator Front Panel Controls

1) Allow all equipment to stabilise for at least 4 hours.

2) To select front panel calibration mode on the calibrator

Enter      

Then press 

Enter  

The calibrator will produce a 2 second beep to confirm front panel calibration mode is selected

3) Select range & output to be adjusted

4) With the required function, range and output set, press the  button

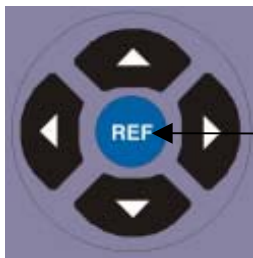

Press REF to enter calibration mode

 The shift button will illuminate when in calibration mode

5) Use the digital control knob to change the measured output (or the displayed resistance / capacitance value) as required.

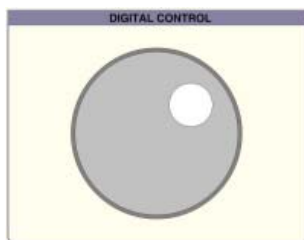

INCREASE



DECREASE

6) Press  again and the SHIFT button illumination will turn off to indicate the adjustment has been saved.

**ONCE CALIBRATION IS COMPLETED  
TURN THE CALIBRATOR OFF, THEN ON AGAIN**

---

## Guarantee and service

---

Transmille Ltd. guarantees this instrument to be free from defects under normal use and service for a period of 3 years from purchase. This guarantee applies only to the original purchaser and does not cover fuses, or any instrument which, in Transmille's opinion, has been modified, misused or subjected to abnormal handling or operating conditions.

Transmille's obligation under this guarantee is limited to replacement or repair of an instrument which is returned to Transmille within the warranty period. If Transmille determines that the fault has been caused by the purchaser, Transmille will contact the purchaser before proceeding with any repair.

To obtain repair under this guarantee the purchaser must send the instrument in its original packaging (carriage prepaid) and a description of the fault to Transmille at the address shown below. The instrument will be repaired at the factory and returned to the purchaser, carriage prepaid.

Note :

**TRANSMILLE ASSUMES NO RESPONSIBILITY FOR DAMAGE IN TRANSIT**

**THIS GUARANTEE IS THE PURCHASER'S SOLE AND EXCLUSIVE GUARANTEE AND IS IN LEIU OF ANY OTHER GUARANTEE, EXPRESSED OR IMPLIED. TRANSMILLE SHALL NOT BE LIABLE FOR ANY INCIDENTAL, INDIRECT, SPECIAL OR CONSEQUENTIAL DAMAGES OR LOSS.**



**Transmille Ltd.  
Unit 4, Select Business Centre  
Lodge Road  
Staplehurst  
Kent  
TN12 0QW  
United Kingdom**

**Tel : +44 0 1580 890700  
Fax : +44 0 1580 890711**

**EMail : [sales@transmille.com](mailto:sales@transmille.com)  
Web : [www.transmille.com](http://www.transmille.com)**





Transmille Ltd.  
Unit 4, Select Business Centre  
Lodge Road  
Staplehurst  
Kent.  
TN12 0QW  
United Kingdom.

Tel : +44 0 1580 890700  
Fax : +44 0 1580 890711

Email : sales@transmille.com  
Web : www.transmille.com

## 3000 Series Fax Back Form

Your 3000 Series Multi-Product Calibrator is fitted with a *security system* which requires a *security code* to be entered to allow continued operation of the unit beyond the 65 Day evaluation period.

Please complete the following details :

Company Name : \_\_\_\_\_

Contact Name : \_\_\_\_\_

Address : \_\_\_\_\_

\_\_\_\_\_

\_\_\_\_\_

\_\_\_\_\_

Country : \_\_\_\_\_

Tel. : \_\_\_\_\_

Fax : \_\_\_\_\_

Instrument Model : 3000 Series Multi-Product Calibrator

Serial Number : \_\_\_\_\_

Please Fax This Form To : +44 (0) 1580 890711

On receipt of this fax Transmille will, on receipt of payment for the calibrator, send details of the security code with details on how to enter this code.